



**KISTLER**

measure. analyze. innovate.

## Engine Combustion Analysis

**Engine Pressure  
Measurement  
for Research and  
Development**

# Kistler – Your Dynamic Partner for Engine Development

Sensors and systems for measuring cylinder and injection pressures delivering key data play a major role in the development of internal combustion engines. They are one of the building blocks of Kistler Instrumente AG's solutions for a wide range of industries. In addition to the development of internal combustion engines, as a Swiss company we also provide special sensors and monitoring systems for engine instrumentation, the automobile industry, manufacturing and assembly, plastics processing and biomechanics.

Kistler's core competency is the development, production and use of sensors for measuring pressure, force, torque and acceleration. With the aid of Kistler expertise and electronic systems, measurement signals can be conditioned and used to analyze, control and optimize physical and other processes to boost product quality.





Year after year the company invests 10 % of its turnover in R&D to facilitate technically innovative yet cost-effective state-of-the-art solutions.

With a combined workforce of 1 000, the Kistler Group is the world leader in dynamic measurement technology. 25 group companies worldwide and 30 distributors ensure close contact with the customer, individual application support and short lead times.



*PiezoStar® – Kistler has been growing their own crystals with high sensitivity and temperature stability for more than ten years*

# Contents

<b>From Crystal to Sensor in 200 Steps</b>	<b>4</b>	
<b>Kistler Pressure Sensors – Varied and Innovative in Design</b>	<b>6</b>	
<b>PiezoSmart® Means Automatic Sensor Identification</b>	<b>8</b>	
<b>Pole Position in all Engines</b>	<b>10</b>	
<b>Fundamentals of Combustion Analysis</b>	<b>12</b>	
<b>Systems for Combustion Analysis – KiBox® for In-Vehicle Applications</b>	<b>14</b>	
<b>System Integration on Test Stand</b>	<b>16</b>	
<b>Made to Measure Service Individualized to Suit Each Customer</b>	<b>18</b>	
<b>Product Details and Range</b>		
Measuring Chains	20	
Measuring	24	
Connecting	43	
Electronics & Software	46	
Accessories	55	
Calibrating	58	
Technical Literature	61	
Glossary	62	
Overview of Products in Order of Type Number	64	

# From Crystal to Sensor...

The manufacture of piezoelectric sensors has much in common with precision watchmaking. Sensor fabrication requires meticulous accurate assembly of individual parts, typically just a few millimeters in size, with up to 200 separate steps needed. These delicate manual operations culminate in precision Kistler measuring equipment that has been subjected to 100 % quality control at various stages. After all, these sensors have to yield reliable, accurate measurements over a long service life.

At the core of a piezoelectric sensor is a crystal measuring element. Application of a mechanical force to this crystal generates, on its surfaces, a proportional electric charge that can be used as a measurement signal. Piezoelectric sensors are particularly suitable for precise measurement of high-speed phenomena over wide measuring ranges and at high temperatures.

## PiezoStar® crystals are individually grown for combustion analysis

Kistler predominantly uses quartz (silicon dioxide (SiO<sub>2</sub>)) as its crystal material. However, for sensors to be used under extreme operating conditions, combustion analysis for example, Kistler grows its own crystals and has done for approximately 10 years. Known as PiezoStar crystal, Kistler then produces customized measuring elements with bespoke characteristics.

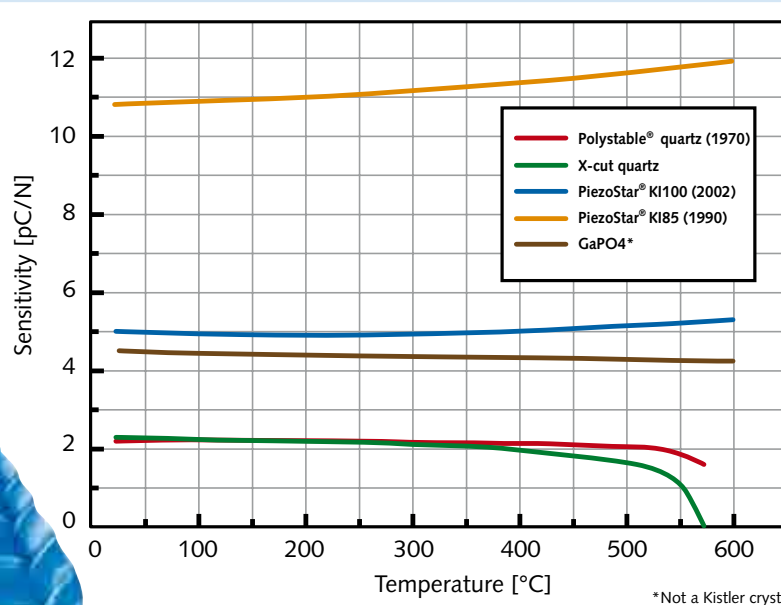

\* Not a Kistler crystal

For each application Kistler offers optimized sensor packages manufactured from different crystal materials





# ...in 200 Steps

This enables the company to offer specially optimized high-performance sensor packages with an extremely high level of accuracy and a long life.

## It all starts with an X-ray

The orientation of the crystal lattice relative to the surfaces of a measuring element is the determining factor in the properties of the element. To ascertain the individual axes of the crystal and hence the planes on which the measuring elements are sliced, each crystal ingot is X-rayed before being processed. Only then is it sliced into thin wafers, an operation which takes up to 24 hours in itself.

## 100 % quality control at each step

The small measuring elements come in a wide variety of shapes and sizes and are formed from the wafers in numerous, mainly manual, intermediate steps. The crystal elements are cut, lapped, coated and re-lapped to the nearest micrometer. Kistler leaves nothing to chance.

After each step, the measuring elements are cleaned and their dimensional accuracy and surface finish is checked. The same applies to all of the other individual parts, such as the case, diaphragm, insulator, contact spring, connector and so on.

## Assembly under cleanroom conditions

The final assembly of the sensors amounts to precision engineering. It is performed under a microscope in a class 5 cleanroom environment. Here, precision and a steady hand are absolutely imperative as the smallest flaw makes a sensor unusable. Therefore each individual step has to be described with strict assembly instructions. Once the sensor has been completed, a laser is used to mark it with a "K" representing the brand, the type designation and the serial number. Final inspection then takes place before all of the data is saved under the sensor serial number in a database.

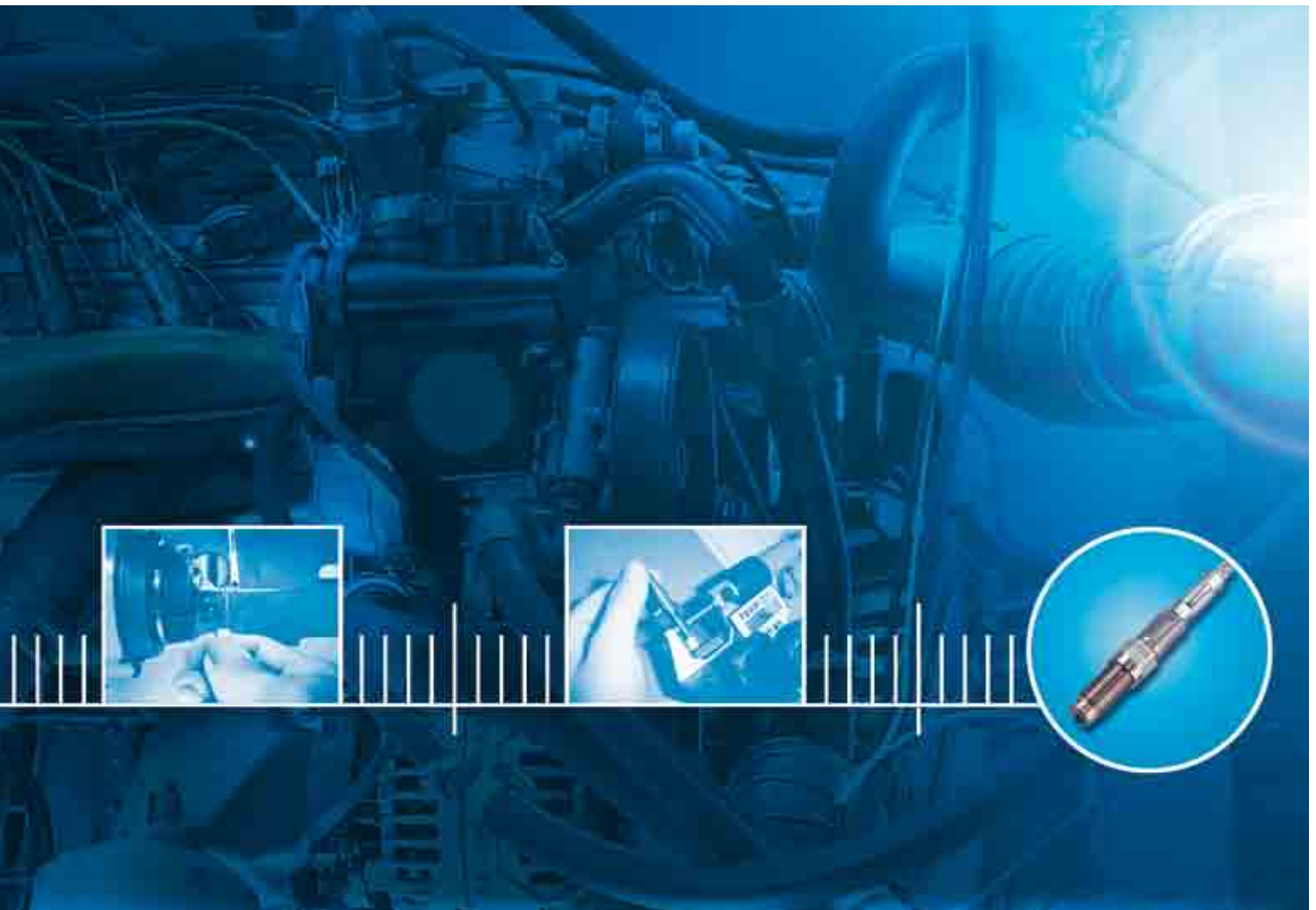

# Kistler Pressure Sensors...

The range of Kistler sensors reflects the multifaceted nature of engine development. Miniature piezoelectric pressure sensors measure cylinder pressures extremely precisely as a basis for thermodynamic analysis of the combustion process. Equally unique are the piezoresistive sensors for very accurate measurement of intake and exhaust manifold pressures.

## Piezoelectric Pressure Sensors

The piezoelectric effect – the prefix "piezo" comes from the Greek "piezein", to press – was discovered in 1880 by the Curie brothers. They found that the surfaces of certain crystals – including quartz – become electrically charged when the crystal is mechanically loaded. This electrical charge is exactly proportional to the force acting on the crystal. It is measured in picocoulombs ( $1 \text{ pC} = 10^{-12}$  coulombs).

As active designs, piezoelectric sensors can only be used for quasistatic rather than truly static measurement. However they are ideal for dynamic applications. Piezoelectric pressure sensors can be employed wherever rapidly changing pressures at temperatures of up to 400 °C have to be measured as accurately as possible.

In addition to quartz, particularly for uncooled sensors, Kistler uses crystals developed and grown in-house. These PiezoStar® crystals are characterized by high sensitivity and high thermal stability.

## Piezoresistive Pressure Sensors

The piezoresistive principle is based on the semiconductor effect first described in 1954, which states that under mechanical stress semiconductors change their electrical resistance. Compared with the conventional strain gage measurement of the time, this opened up completely new applications. Since then similar breakthroughs have included the thin film technique on metal and its thick layer counterpart on ceramic.

Piezoresistive sensors from Kistler measure static pressures in gases and liquids. The results achieved under even the most adverse conditions are precise and repeatable.

### Applications at a Glance

1. Precision measurement of cylinder pressures with cooled PiezoStar cylinder pressure sensor for combustion analysis, gas exchange analysis and combustion development
2. Measurement of cylinder pressures without additional mounting bore for the sensor.  
**Measuring spark plugs:**  
For knocking analysis and use in the vehicle  
**Glow plug adapters:**  
For measurement in DI diesel engines. Also available as measuring glow plugs for cold start measurements
3. Pressure indication with uncooled piezoelectric PiezoStar sensors for thermodynamic analysis and engine calibration
4. Low-pressure indication in the intake and exhaust with piezoresistive pressure sensors. Cooling or switching adapters are used for this purpose in the exhaust. Such instrumentation is employed for gas exchange analysis and optimization



M8 cooled piezoelectric pressure sensor, Type 6041B...



M5 piezoelectric pressure sensor, Type 6052C...



M5 piezoresistive absolute pressure sensor, Type 4005B...

➔ For more information on the topic of uncooled sensors, please refer to page 24.

➔ For more information on the topic of cooled sensors, please refer to page 30.

# ...Varied and Innovative in Design

A capacity for innovation, close contact with the world's leading engine manufacturers and skilled application expertise help explain why Kistler sets the pace for engine measurement. Kistler always offers the best solution for accurate pressure measurement over a wide spectrum of sectors from extremely high-precision research to demanding racing applications.

## Reliable Development Partner for Research and Industry

It achieves all this by drawing on an extensive range of products that complement piezoelectric and piezoresistive sensors with matching signal conditioning and a diverse selection of accessories. Such a comprehensive choice ensures, the perfect sensor package is coupled with the ideal signal conditioning which can always be used for the maximum accuracy in each individual pressure indication project.

The modularity of Kistler sensors allows for cost effective customization. This further increases the benefits for the customer by always ensuring accurate measurements, even with special sensor configurations or service conditions.

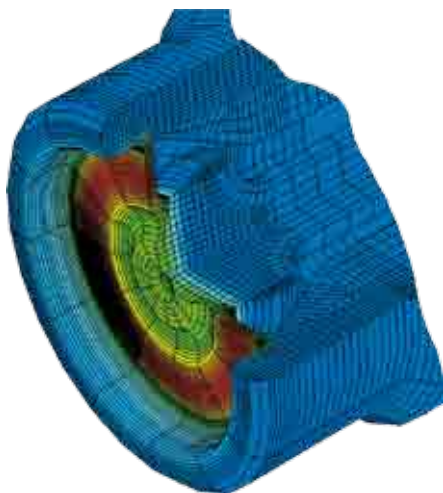

FEM-model of a front sealing sensor

## Simulation and Calculation

A wide operating temperature range, impressive thermal stability and a high natural frequency represent the inherent advantages of the piezoelectric measurement for engine combustion pressures. During operation in this difficult environment the sensors are subjected to significant thermal and mechanical influences and measures taken to minimize these effects often have aims that conflict in many complex ways.

To tackle this complexity and to identify potential resolutions to their conflicts, Kistler uses sophisticated calculations and simulation tools within the sensor development process. Starting with a model that represents the geometric, mechanical and thermal properties of a sensor, the effects of a wide variety of factors on the measurement results can be analyzed and described quickly and efficiently.

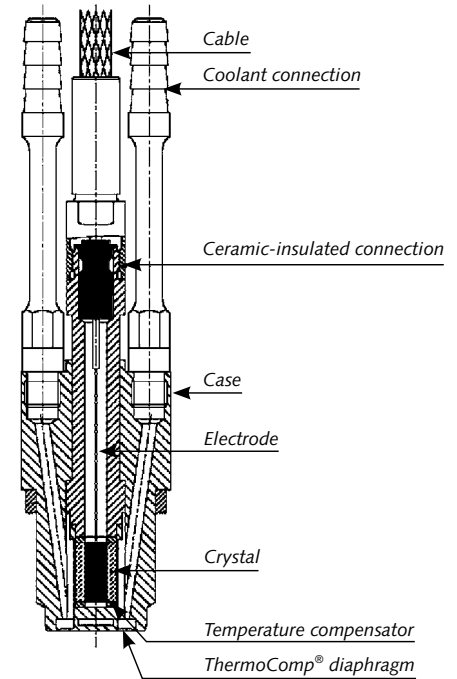

Cooled sensor

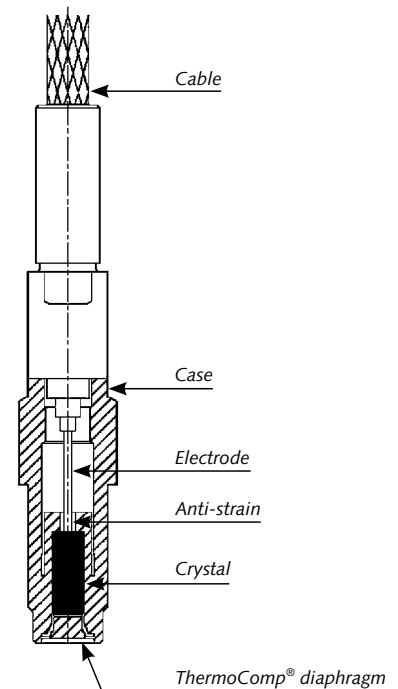

Uncooled sensor

# PiezoSmart® ...

Detailed planning, comprehensive configuration of measuring chain parameters and precise assignment of measuring points – even the preparations for engine pressure indication are enormously involved. Production of the necessary documentation and related procedures is labor-intensive and error-prone. In combination with the signal conditioning platform (SCP), PiezoSmart automatic sensor identification offers test stand operators enhanced process reliability, extensive flexibility and improved data quality with less preparation.

PiezoSmart is an active system for the automatic identification of individual pressure sensors. Plug & Measure (automatic configuration of measuring chain parameters) reduces the risk of error and additional functions guarantee the quality of the pressure indication data. Two points of particular importance to the end user are that:

- PiezoSmart is suitable for all engine pressure sensors and all existing cable and connector combinations
- PiezoSmart modularity allows for the upgrading of existing or used sensors with sensor identification

## Unambiguous assignment of sensor data

The core of PiezoSmart is the transducer electronic data sheet (TEDS). Sensor data is saved in the TEDS, which takes the form of a chip in the connector at the amplifier end of the sensor cable. The connector and pressure sensor form an easily mounted physical unit which ensures reliable, clear-cut assignment of sensor data during test stand operation. Additional system integrity is provided by a seal or self-adhesive markings.

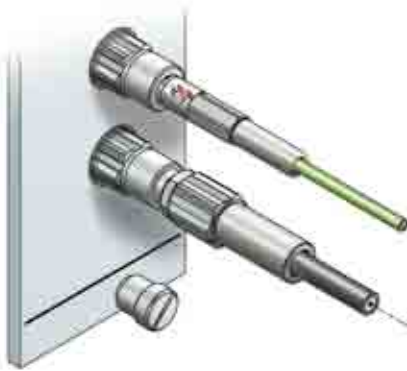

Automatic setting of sensitivity values

Initial calibration (read only)		23 °C	50 °C	200 °C	330 °C
50 bar		20,01	19,98	19,97	19,97
100 bar		20,00	20,00	19,99	19,99
Recalibration (read/write)		23 °C	50 °C	200 °C	330 °C
50 bar		19,98	19,98	19,96	19,96
100 bar		19,97	19,96	19,96	19,94
150 bar		19,97	19,95	19,95	19,94
200 bar		19,95	19,94	19,94	19,93

Optimum sensitivity value automatically set to suit utilized pressure measuring range and defined temperature range

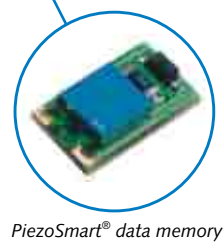
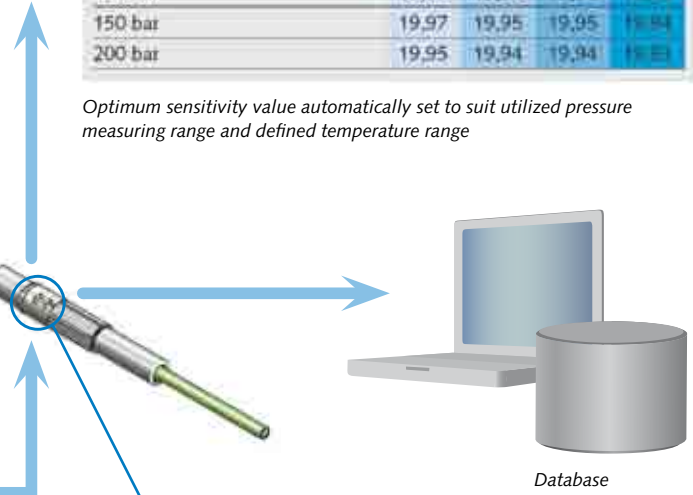

PiezoSmart® data memory



# ...Means Automatic Sensor Identification

The TEDS contains the serial number, initial and current calibration values of the sensor, additional manufacturer and identification data. Monitoring of the initial and re-calibration values of the individual sensors allows early detection of sensor anomalies. This in turn helps limit test stand failures and the loss of data.

The chips have hierarchical password-protected access and are write protected to allow the user to make any necessary sensor re-calibration or for the replacement of faulty sensors and cables.

## Standalone operation

Decentralized storage of sensor data means PiezoSmart permits independent operation of the sensor and measuring chain. Consequently, the system is ready for use at any time, a host database is not necessary.

## Interfacing the sensor to the test stand

The signal conditioning platform (SCP) provides the link between the sensor and the test stand. As a flexible equipment platform, measuring modules are installed to support particular test configurations and sensor selection.

## Clear assignment of data to a sensor

The sensor and connecting cable with the TEDS form a physical unit, i.e. they are permanently connected and do not need to be disconnected even to mount the sensor.

The connection integrity is shown by the presence of a seal. The individual parts are spot welded together in the factory and supplied with this seal. After any upgrade, the seal or a sticker with the "Kistler-K" at the line of the break shows that the connection is intact.

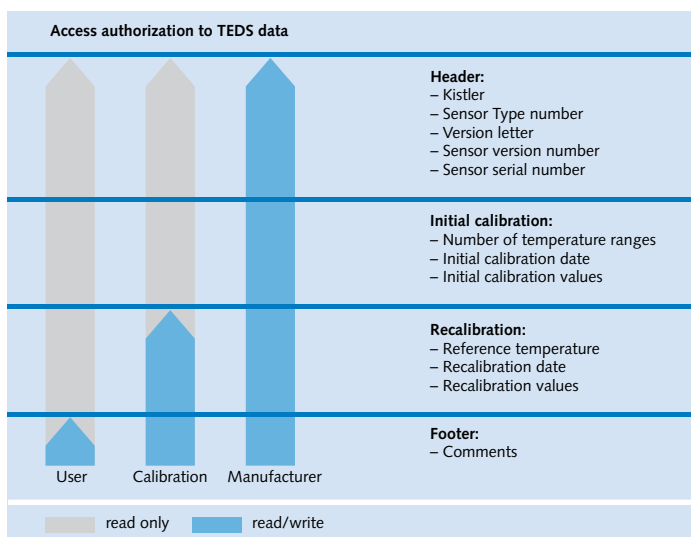

Hierarchical access and write authorization

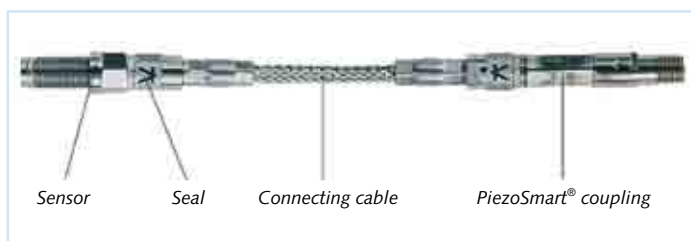

Unit with sensor, connecting cable and TEDS

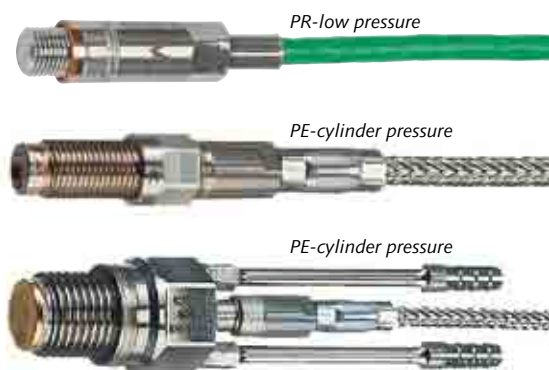

Examples of sensors with PiezoSmart®

## Advantages at a Glance

- Automatic configuration of charge and voltage amplifier parameters
- Accurate pressure indication data from simplified measurement
- Simple setup processes speed up readiness for measurement on test stand
- Easy evaluation and documentation of measurements through automatic exchange of data with evaluation systems
- High availability of pressure indication sensors ensured by multi-channel calibration systems

→ For more information on the topic of Upgrading, please refer to page 18.

# Pole Position...

From pioneer to technological leader – Kistler has been involved in the development, manufacture and application of piezoelectric sensors since 1950. The company's sensors have played a key role in the development of internal combustion engines over this extended period. This striking success reflects their "inside view" of the combustion chamber as the only source of information needed to optimize combustion for better efficiency and minimize harmful emissions.

The development of measuring instrumentation for engine improvement is closely linked with the history of Kistler as a company. It all began in 1944, when the two subsequent founders of today's Kistler Instrumente AG, Hans-Conrad Sonderegger and Walter P. Kistler, got to know each other at SLM (Swiss locomotive and machinery works) in Winterthur. Sonderegger was responsible for developing a new air-cooled diesel engine and Kistler for modern measurement methods.

The breakthrough came in 1950 with the grant of a patent for charge amplifiers – the devices that convert the signal of piezoelectric sensors into a useful voltage. Just a few months later the PZ-14 piezoelectric pressure sensor, which formed the nucleus of many subsequent designs, was developed.

Kistler has been developing and producing piezoelectric pressure sensors since 1959. They are still delivering reliable results under even the most extreme conditions.



Marine engines

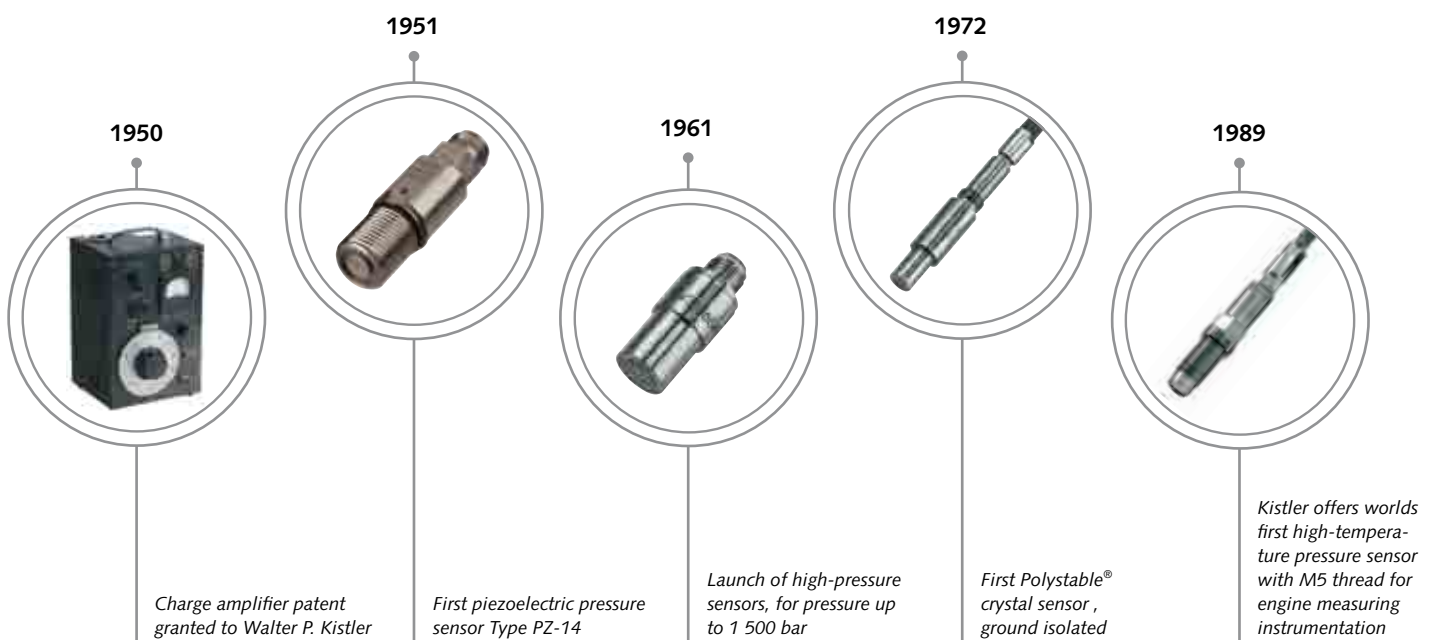

# ...in all Engines



Motorbike engines



Car engines



Locomotive engines

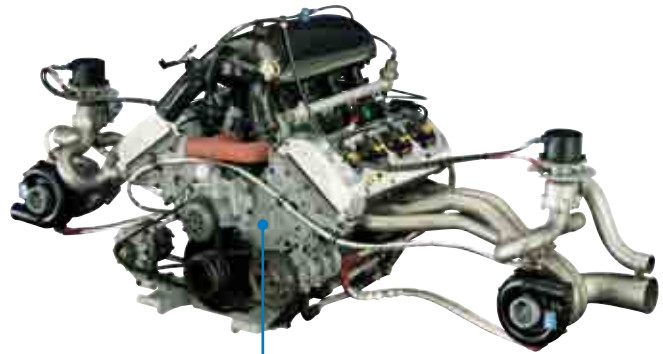

Race engines

1992

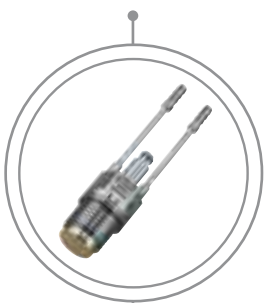

First water-cooled ThermoComp® sensor

1993

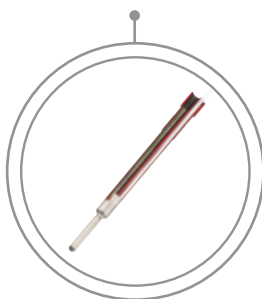

First measuring glow plug for pressure measurement in diesel engines

2004

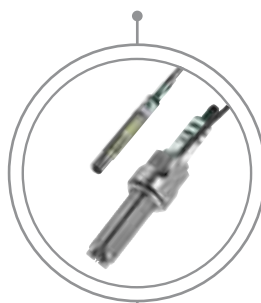

First use of PiezoSmart® sensors in engine measuring instrumentation and M10 measuring spark plug for racing

2007

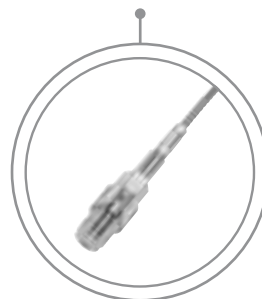

Piezoelectric high-temperature sensor

2010

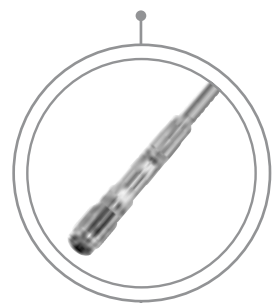

Smallest PE sensor Type 6054AR...

# Fundamentals of Combustion Analysis

Development and optimization of modern internal combustion engines is inconceivable without the knowledge of what is happening in the cylinders. Measurement and analysis of the variation in cylinder pressure is the only source of the data needed to optimize efficiency, engine output, emissions and last but not least engine life. The better the data the more valuable the information that is derived.

Reciprocating piston internal combustion engines are basically heat engines in that they essentially convert the chemical energy from the air/fuel mixture into mechanical work and heat by means of combustion.

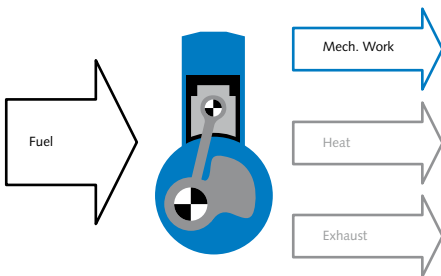

Conversion of chemical energy from fuel into mechanical work and heat

Developers aim to extract from the conversion as high a proportion of mechanical work as possible, that is to maximize efficiency. The magnitude and variation with time of the cylinder pressure acting on the piston are significant in this respect. This pressure curve represents the combustion and hence the way in which the energy conversion takes place in the engine. Consequently, the total mechanical work on the piston over a cycle is a function of the pressure and the associated change in combustion chamber volume.

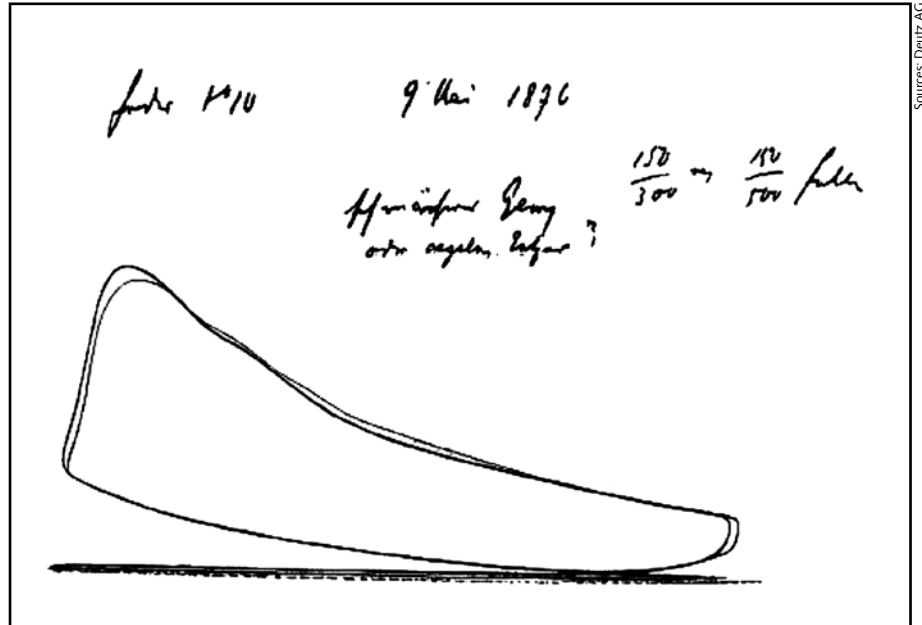

Indicator pV diagram recorded by Nikolaus Otto in 1876

Based on this knowledge, Nikolaus Otto and Rudolf Diesel pioneered the use of indicators allowing simultaneous recording of combustion chamber pressure and piston position.

In the German-speaking world "indication" currently refers to all work related to analysis of the pressure curve in combustion engines. Depending on the application, rather than being limited to the actual combustion this now covers gas exchange, injection system, ignition system, etc. English-speaking regions mainly talk about "combustion analysis".

Combustion analysis or engine pressure indication is regarded as a basic tool in engine development and is the key to

- improving efficiency
- increasing engine output
- reducing emissions
- prolonging engine life

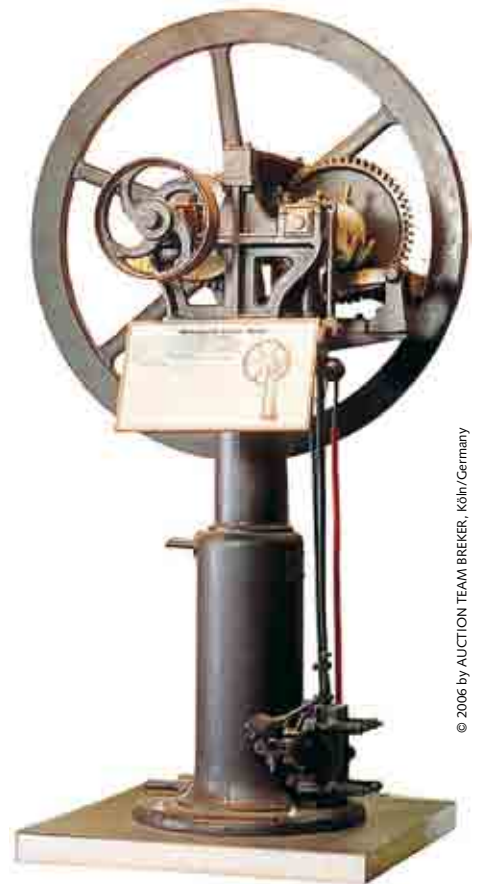

Otto engine of 1870

Sources: Deutz AG

© 2006 by AUCTION TEAM BREKER, Köln/Germany



## Cylinder Pressure Analysis

For most applications combustion analysis data is shown relative to top dead center (TDC) of the power stroke or to a particular combustion cycle. The most important source of information in indication is the cylinder pressure curve. Both the signal level and the variation relative to the position of TDC are important in this regard.

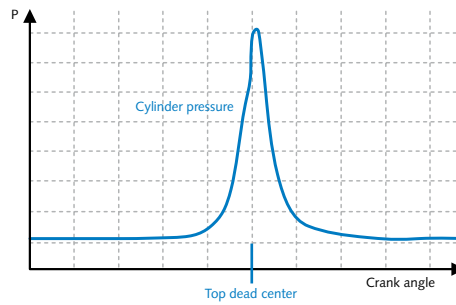

Cylinder pressure curve over cycle of 4-stroke diesel engine

## Gas Exchange Analysis

Gas exchange analysis is used to evaluate and optimize filling of an individual cylinder: the better the filling, the higher the achievable cylinder output. However, fuel consumption and emission characteristics can also be optimized with the aid of the data provided. This can be important if the engine developer wants to employ a variable valve train to influence the gas exchange in a flexible manner, or wishes to modify the induction process with a variable intake manifold, etc.

In all application sectors engines and combustion systems have reached a level of complexity that could not be mastered without pressure indication measurement. For research, development and the tuning of engines, pressure indication provides the only basis for complying with emission legislation and meeting performance and consumption expectations.

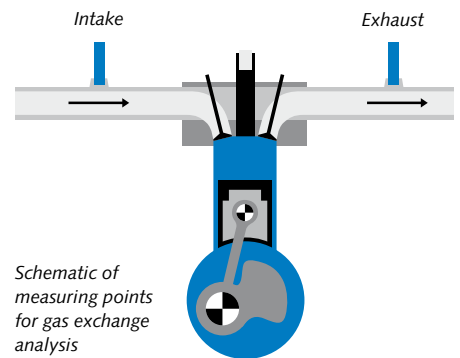

Schematic of measuring points for gas exchange analysis

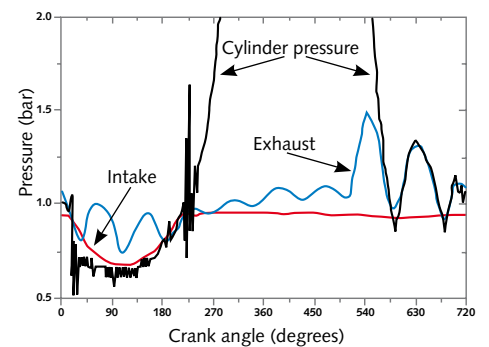

Pressure curves in intake manifold, cylinder and exhaust manifold. In the interest of clarity the compression and combustion pressure of the measured curves are truncated at 2 bar

### Kistler Know How

The data calculated from cylinder pressure signals and resultant information includes:

Derived data	Information provided on
Peak pressure	Mechanical load on drivetrain
Indicated mean effective pressure, complete 4-stroke cycle or high-pressure component only	Cylinder output Combustion stability (cyclical fluctuations) Misfiring Response Friction losses
High-frequency component of vibration	Knocking
Pressure gradient	Combustion noise
Crank angle at peak pressure Heating curve and energy conversion points	Overall efficiency Combustion efficiency Qualitative exhaust values Quality of ignition system
Gas temperature	Qualitative exhaust values
Low-pressure component of the indicated mean effective pressure, $pV$ diagram	Gas exchange losses
Combustion curve	Energy balance
Mass flow rate	Filling of cylinder Residual exhaust gas in cylinder Backflow Gas exchange losses
Ignition delay, calculated from ignition or injection point and start of combustion	Formation of air/fuel mixture

# Systems for Combustion Analysis...

## Measuring

Kistler PiezoStar® crystals provide the foundation for an optimized sensor design providing precision measurements from a miniature device. Combined with engine-specific adapters and the appropriate

accessories these sensors produce readings that deliver the very best possible results. To analyze gas exchange, Kistler offers absolute pressure sensors based on the piezoresistive measuring principle.



## Amplifying

High-performance measurement amplifiers convert the raw pressure signal into a precision-scaled voltage which forms the interface between sensor signal and measuring system in the tried-and-tested Signal Conditioning Platform (SCP).

The "PiezoSmart®" automatic sensor identification system is based on the TEDS (Transducer Electronic Data Sheet) protocol. This system automatically configures all cylinder and low pressure amplifiers and records the operating time, ensuring a high level of flexibility, data quality and process reliability.

# ...KiBox<sup>®</sup> for In-Vehicle Applications

The development, production and practical application of piezoelectric sensors and amplifiers has been Kistler's core business since the 1950s. Even then our technology was being used in the research and development of internal combustion engines, both industrial and automotive. The ability

to precisely measure and record extremely dynamic pressure conditions in cylinders led to high levels of efficiency and lower emission values common in modern engines. For over ten years we have been growing piezoelectric crystals in-house, specifically for use in combustion pressure sensors. However, the precision of

the results is determined not only by the sensor properties alone but also by an application-specific measuring chain that includes connecting cables, amplifiers and an evaluation system. Our range of combustion analysis products is the result of decades of intensive collaboration with our customers.



## Analysis

Working in close collaboration with users, Kistler has taken a significant step in providing a development tool that will improve the quality of data and help to reduce the overall development time for new vehicles. Kistler realized that the only way to give

combustion development and automotive calibration engineers the information they need to perform their everyday tasks is to analyze the measured signals and the resultant parameters. By developing the KiBox, Kistler has now added to its product

range a combustion analysis system designed specifically for in-vehicle use. Standardized interfaces, powerful PC technology and the option to use the proven SCP amplifier modules ensure that the customer's investment is both well protected and well utilized. The same factors also mean that the user has a tool that is easy to use and can deliver extremely precise results after a very short set-up period.

# System Integration on Test Stand

Sensors, cables, charge amplifiers and the signal conditioning system from Kistler can be readily configured for different combustion analysis tasks. Standardized interfaces ensure that the signal processing system is compatible with a wide variety of test configurations and test stand environments. The PiezoSmart automatic sensor identification system ensures the seamless exchange of data between sensor and evaluation electronics. This meets the essential requirements for quick and easy evaluation and analysis of measurement data.

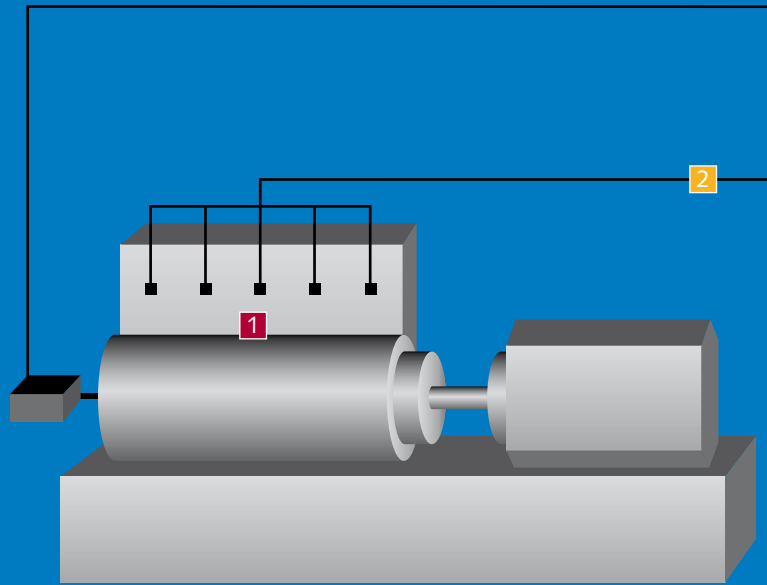

## Accessories

## 1 Measuring

## 2 Connection



*Crank angle encoder*



*Combustion pressure*



*Low-impedance cables*



*TDC sensor*

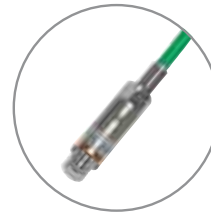

*Intake/exhaust*



*High-impedance cables*



*Cooling unit*



*Injection pressure*



*Oil-resistant cables*

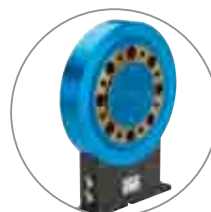

*Torque*



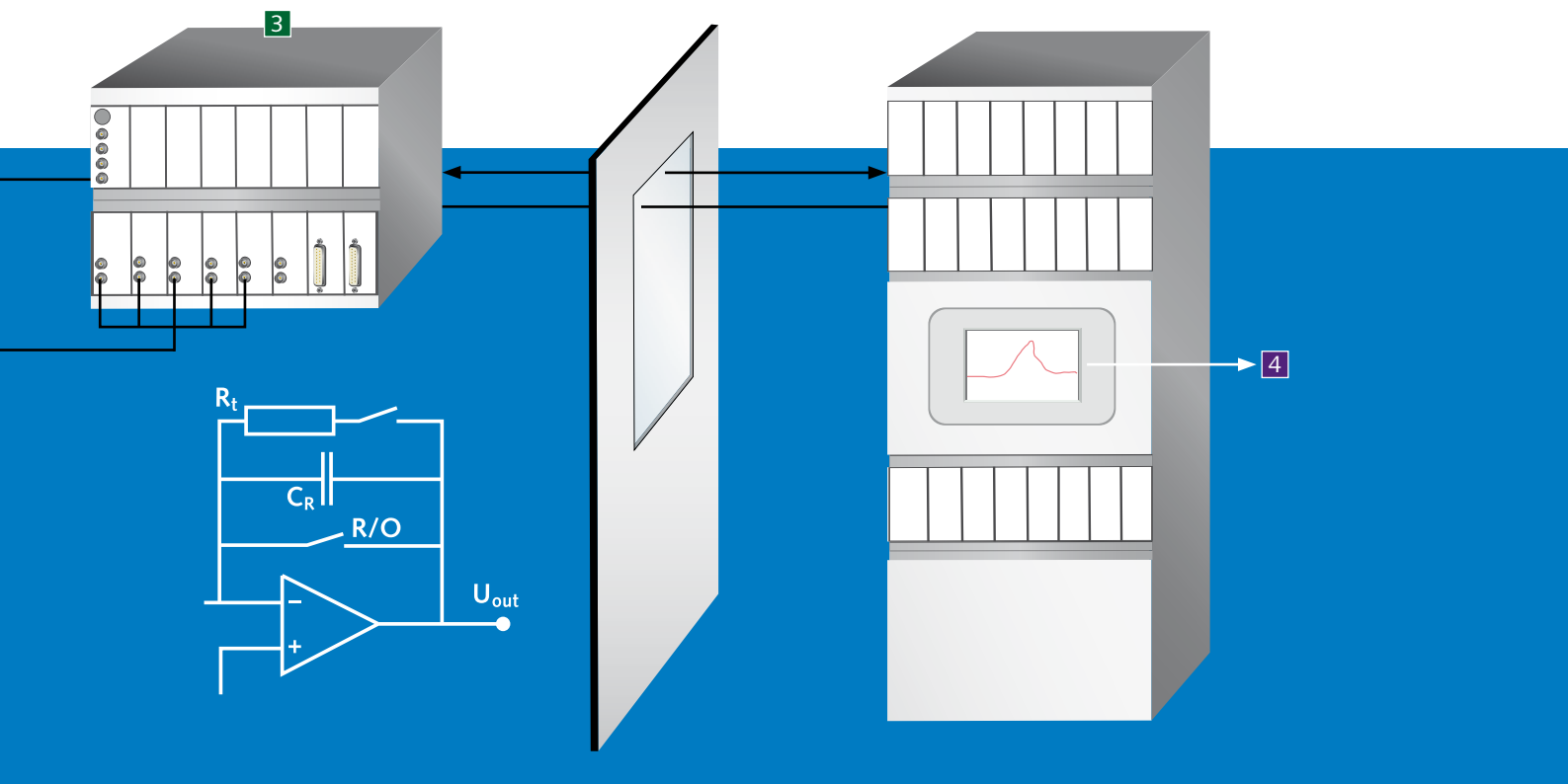

### 3 Amplification/Conditioning

### 4 Acquisition/Analysis

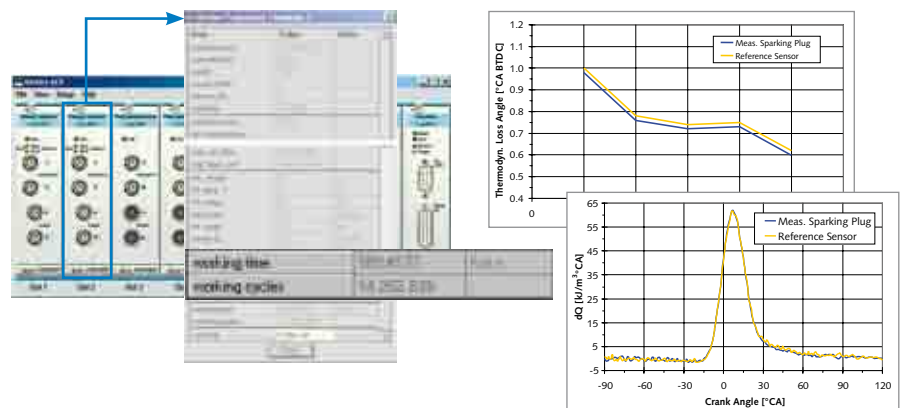

Signal preparation in the signal conditioning platform (SCP), an integrated equipment platform with measuring function modules.

PiezoSmart allows automatic configuration of measuring chain parameters for greater process reliability and automatic recording of sensor operating time and pressure cycles.

The high-precision sensor system in combination with accurate signal conditioning makes even the smallest changes in pressure available for analysis.



# Made to Measure Service...

Kistler's broad range of support services extend from application engineering, on-site calibration through to the development of customized sensors. Additional resources are dedicated to providing high quality sensors and customer oriented training courses.

From choosing the right sensor through to correct mounting, Kistler's Application Engineering personnel support and advise the customer as required on all questions relating to engine pressure indication. The aim is to ensure that the measurement is always performed with the technology yielding the maximum benefit and of course, to ensure a sensor operates at maximum accuracy over a long service life.

## Adding PiezoSmart® Sensor Identification

The modularity of the sensors allows both user or factory upgrading to PiezoSmart. Depending on the required configuration a Triax connector or coupler can be added to an existing sensor or, if necessary, the entire cable assembly can be replaced with a PiezoSmart cable. This ensures that the user can integrate existing sensors into a new test stand and quality assurance procedures.

→ For more information on the topic of PiezoSmart®, please refer to page 8 or to PiezoSmart® System Description Doc. No. 100-421.

## Training and Information

Kistler augments the selection of services on offer by disseminating specialist knowledge and expertise in the form of presentations and papers at conferences, symposia, exhibitions and trade shows. In addition, regular basic and advanced training seminars are held for customers covering topics related to measurement and combustion.

This range of services also includes the availability of an extensive library of reference material in either hard-copy or electronic form with data sheets, brochures, manuals and application papers being the most popular.

### Advantages at a Glance

- Customized versions of sensors
- Upgrading with PiezoSmart sensor identification
- Factory and on-site calibration service
- Standards for calibrating sensors
- Basic and advanced customer training seminars
- Installation and process instructions for sensors
- Literature and information leaflets for specific applications

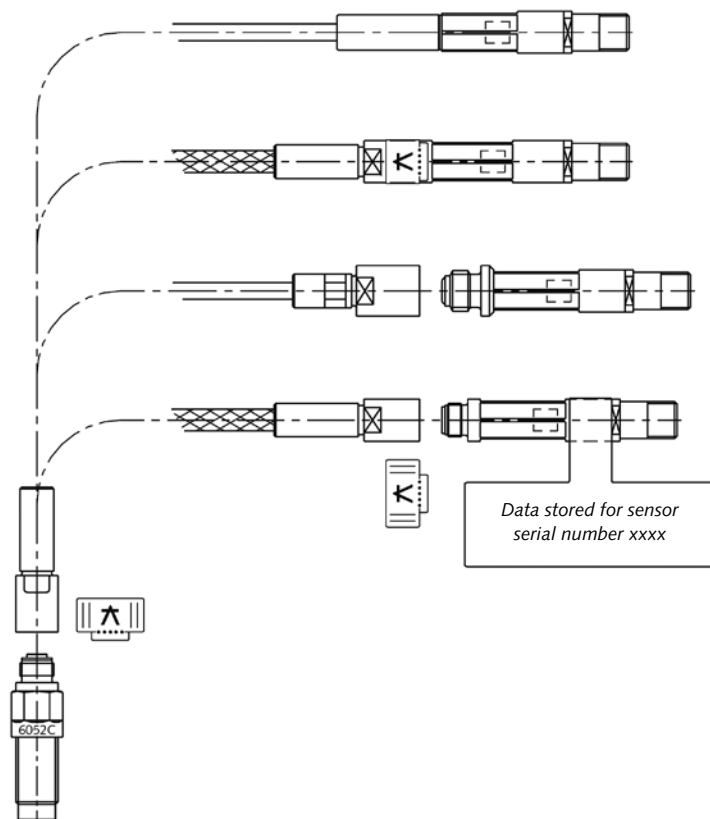

# ...Individualized to Suit Each Customer

## Calibration Service

The Calibration Service always operates under strict adherence to all relevant quality assurance and procedural guidelines. Naturally this includes comprehensive documentation and archiving to ensure traceability and continuity of sensor calibrations.

If operational requirements or cost restricts the transportation of sensors and equipment to Kistler, then Kistler can bring the calibration service to the customer. The calibration can be performed quickly and cost effectively in-situ with semi and fully automatic calibration equipment.



Various pressure generators, reference sensors and charge calibrators are available for calibrating the sensors and charge amplifiers

→ For more information on the topic of calibration, please refer to page 58 onwards.

## Customized Sensors

The Kistler range encompasses well over 1 000 different pressure sensors for engine pressure indication, providing a suitable sensor package for virtually any task.

There are cases however, where particular testing requires either an improved performance or where a customized sensor is needed to optimize the total test package. In these situations Kistler develops with the customer an individualized version, which, thanks to the modularity of the sensors and wealth of different adapters, cable and connector combinations, can generally be manufactured at a reasonable cost.



Measuring spark plug

















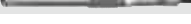

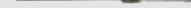
Glow plug adapters for developing diesel engines

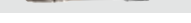

Oil-resistant connectors and cable connections for routing cable in cylinder head

# Measuring

## High-pressure Sensors for Measuring Cylinder Pressure

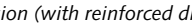
Type	Mounting thread	Mounting diameter	Design						Pressure range	Temp. range min./max.	Accessories		
			Sensor	Probe	Measuring spark plug	PiezoSmart® sensor identification available	Cooled	Uncooled			6473A... mounting nut (M10x1)	6474A... mounting nut (3/8" x24 UNF)	6472Asp mounting sleeve
Sensor													
6052C... 	M5x0,5	4,4 mm	✓		☉	✓	✓	0 ... 250/... 300 bar*	-20 ... 350 °C				
6053CC... 	M5x0,5	4,4 mm		✓	☉	✓	✓	0 ... 250/... 300 bar*	-20 ... 350 °C				
6054AR... 	M5x0,5	4,4 mm	✓		☉	✓	✓	0 ... 300 bar	-20 ... 350 °C				
6055C... 	M5x0,5	4,4 mm		✓	☉	✓	✓	0 ... 250/... 300 bar*	-20 ... 350 °C				
6056A... 	M5x0,5	4,4 mm		✓	☉	✓	✓	0 ... 250/... 300 bar*	-20 ... 350 °C				
6058A 	M5x0,5	4,0 mm		✓	☉	✓	✓	0 ... 250 bar	-20 ... 350 °C				
6041B 	M8x0,75	11,5 mm	✓		☉	✓	✓	0 ... 250 bar	-20 ... 350 °C				
6043A... 	M8x0,75	9,8 mm		✓	☉	✓	✓	0 ... 250/... 300 bar*	-20 ... 350 °C				
6061B... 	M10x1	13,5 mm	✓		☉	✓	✓	0 ... 250/... 300 bar*	-20 ... 350 °C				
6067C... 	Mounted in sleeve	9,9/12,6 mm	✓		☉	✓	✓	0 ... 250/... 300 bar*	-20 ... 350 °C				●
7061B... 	M14x1,25	16 mm	✓		☉	✓	✓	0 ... 250 bar	-20 ... 350 °C				
6045A... 	M8x0,75	9,8 mm	✓		☉	✓	✓	0 ... 250/... 300 bar*	-20 ... 350 °C				
6081A... 	M5x0,5	4,0 mm		✓	☉	✓	✓	0 ... 250 bar	-20 ... 200 °C				
6125C... 	M10x1, 3/8" x24 UNF	6,2/8,5 mm	✓		☉	✓	✓	0 ... 300 bar*	-20 ... 350 °C			●	●
6113B... 	M10x1				✓	☉	✓	0 ... 200 bar	-20 ... 200 °C				
6115B... 	M12x1,25				✓	☉	✓	0 ... 200 bar	-20 ... 200 °C				
6117B... 	M14x1,25				✓	☉	✓	0 ... 200 bar	-20 ... 200 °C				
6118B... 	M14x1,25				✓	☉	✓	0 ... 200 bar	-20 ... 200 °C				







\*...U20 version (with reinforced diaphragm) \*\* Assortment of common adapters, connecting cables and couplers











# Measuring





## Low-pressure Sensors for Intake/Exhaust Measurement

Type	Mounting thread	Measuring range (absolute)	Temperature range min./max.	Sensor version		Mechanical adapter				Cooling	
				Standard	PiezoSmart	6596 adapter M14x1,25	6598 adapter M12x1	7501 adapter M14x1,25	7503 adapter M5	7533A... switching adapter M14x1,25	7525A... M14x1,25
<b>Sensor</b>		<b>In the printed version the measuring range (absolute) Type 4005B... and Type 4007B... have been mixed up. In this PDF the values are displayed correctly.</b>									
<b>4005B...</b> 	M5x0,5	0 ... 2/... 5/... 10/... 20/... 50/... 100/... 200/... 400 bar	-40 ... 125 °C	4005BA...	-----	-----	-----	-----	-----	-----	-----
					4005B...V200S	-----	-----	-----	-----	-----	-----
<b>4007B...</b> 	M5x0,5	0 ... 5/... 250 bar	-40 ... 200 °C	4007BA...	-----	-----	-----	-----	-----	-----	-----
					4007B...S	-----	-----	-----	-----	-----	-----
<b>4043A...</b> 	M14x1,25	0 ... 1/... 500 bar	-40 ... 70 °C	4043A...	-----	-----	-----	-----	-----	-----	-----
					4043A...V200S	-----	-----	-----	-----	-----	-----
<b>4045A...</b> 	M14x1,25	0 ... 1/... 500 bar	0 ... 140 °C	4045A...	-----	-----	-----	-----	-----	-----	-----
					4045A...V200S	-----	-----	-----	-----	-----	-----
<b>4073A...</b> 	M12x1	0 ... 10/... 500 bar	-40 ... 70 °C	4073A...	-----	-----	-----	-----	-----	-----	-----
					4073A...V200S	-----	-----	-----	-----	-----	-----
<b>4075A...</b> 	M12x1	0 ... 10/... 500 bar	0 ... 140 °C	4075A...	-----	-----	-----	-----	-----	-----	-----
					4075A...V200S	-----	-----	-----	-----	-----	-----
<b>4049A...</b> 	M14x1,25	0 ...5/...10 bar	0 ... 1 100 °C (water cooled)	4049A...S	-----	-----	-----	-----	-----	-----	-----

## High-pressure Sensors for Injection

Type	Sensor	Measuring chain	Mounting thread	Design		Measuring range (absolute)	Temp. range min./max.	Sensor version		Clamp adapter						
				piezoelectric	piezoresistive			Standard	PiezoSmart	6533A21 (cable 6 mm)	6533A22 (cable 1/4")	6533A28 (cable 8 mm)	6533A28 (cable >8 ... 13 mm)	6533A11 (cable 6 mm)	6533A12 (cable 1/4")	6533A18 (cable 6 ... 8 mm)
<b>4065A...</b> 	✓		M7x0,75	✓		0 ... 200/... 1 000 bar	0 ... 120 °C	4065A...	-----	-----	-----	-----	-----	-----	-----	-----
									4065A...S	-----	-----	-----	-----	-----	-----	-----
<b>4067...</b> 	✓		M10x1	✓		0 ...1000/... 5 000 bar	0 ... 120 °C	4067...	-----	-----	-----	-----	-----	-----	-----	-----
									4067...S	-----	-----	-----	-----	-----	-----	-----
<b>6229A...</b> 	✓		M10x1	✓		0 ... 5 000 bar kalibrierter Teilbereich 0 ... 500 bar	-20 ... 200 °C	6229A...	-----	-----	-----	-----	-----	-----	-----	-----

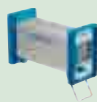
adapter	Connecting cable	Extension cable	Amplifier			More information
7511 M14x1,25 7507 M14x1,25 7505 M18x1,5	Cable at sensor with length of 2 m Cable at sensor with length of 0.5 m 4751A... <70 °C 4753A... <70 °C 4761B... <200 °C 4763B... <200 °C 4765B... <200 °C 4767B... <200 °C 4757A...		4618A...  analog amplifier	4603B...  laboratory amplifier	4665  SCP piezoresistive amplifier	
						Page 36
						Page 36
						Page 38
						Page 38
						Page 38
						Page 38
						Page 38
						Page 38
						Page 38

	Mech. adapter	Connecting cable	Extension cable	Piezoresistive amplifier	Piezoelectric amplifier	More Information
6533A19 (cable 8 ... 13 mm) 6533A110 (cable 13 ... 20 mm) 6919 adapter for 6906 pressure gen. 6925 adapter for 6906 pressure gen. 4155 adapter M14x1,25 6503 adapter M10x1 6447 dummy sensor 6449 dummy sensor		Cable at sensor with length 2 m Cable at sensor with length 0.5 m 4751A... <70 °C 4761B... <200 °C 1631C... <200 °C (KIAC 10-32 pos.-BNC pos., <200 °C) 4757A... 1603B... (BNC neg. - BNC pos.)		4618A...  analog amplifier	4665  SCP piezoresistive amplifier 5018A...  laboratory charge amplifier 5064B21  SCP charge amplifier	
						Page 40
						Page 40
						Page 40

 for PiezoSmart® sensors

## Piezoelectric Sensors

### PiezoStar Miniature Sensors and Measuring Probes

M5 sensor

M5 sensor

M5 measuring probe

4,4 mm measuring probe  
M5 thread set back

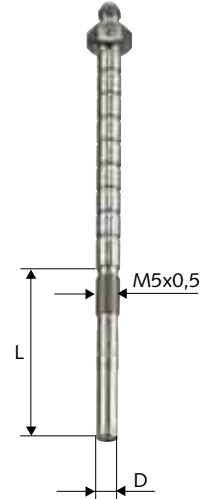
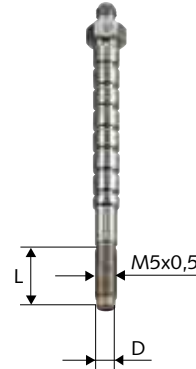
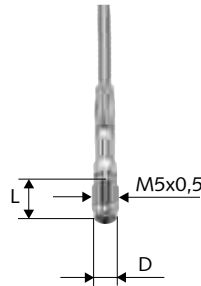

Technical data	Type 6052C...	Type 6054AR...	Type 6053CC...	Type 6055C...
Measuring range	bar	0 ... 250/... 300*	0 ... 300	0 ... 250/... 300*
Sensitivity	pC/bar	≈-20/ ≈-19*	-14	-20
Natural frequency	kHz	≈160	≈160	≈160
Linearity	%FSO	≤±0,3/≤±0,5*	≤±0,3	≤±0,4
Temperature range	°C	-20 ... 350	-20 ... 350	-20 ... 350
<b>Sensitivity change</b>				
200 °C ±50 °C	%	≤±0,5	≤±0,5	<±0,5
23 ... 350 °C	%	≤±2/≤±3*	≤±2	<±2
<b>Thermal shock at 9 bar p<sub>mi</sub> (1 500 1/min)</b>				
Δ p (short term)	bar	≤±0,5/≤±0,7*	≤±0,5	≤±0,5
Δ p <sub>mi</sub>	%	≤±2/≤±3*	≤±2	≤±2
Δ p <sub>max</sub>	%	≤±1/≤±1,5*	≤±1	≤±1
<b>Dimensions</b>				
D	mm	4,4	4,4	4,4
L	mm	10	10	14,5
<b>Characteristics</b>				
		Miniature high-temperature sensor with front seal, high sensitivity, low thermal sensitivity drift, compensated for acceleration, low thermal shock error, long life. Compact dimensions with M5x0,5 thread.	As for Type 6052C... . With reduced mounting dimensions. Direct mounting in ø5,7 mm bore.	As for Type 6052C... . Probe with thread set back, only requires 4,5 mm mounting hole. Suitable for measurements with glow plug adapter Type 6535Q... from 5 mm diameter.
<b>Data sheet</b>				
		6052C_000-552	6054AR_000-844	6053CC_000-571
<b>Mounting bore</b>				

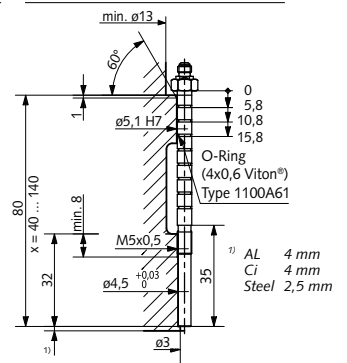
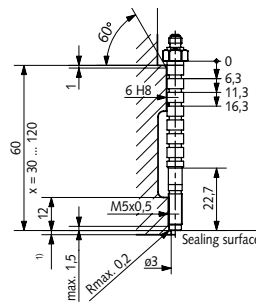
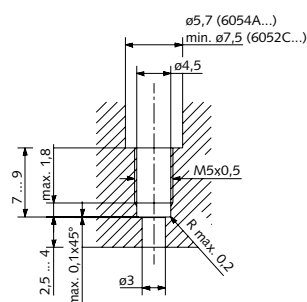

\*...U20 version (with reinforced diaphragm)



# Measuring

## Piezoelectric Sensors

### Sleeve Mounting

Type 6052C...

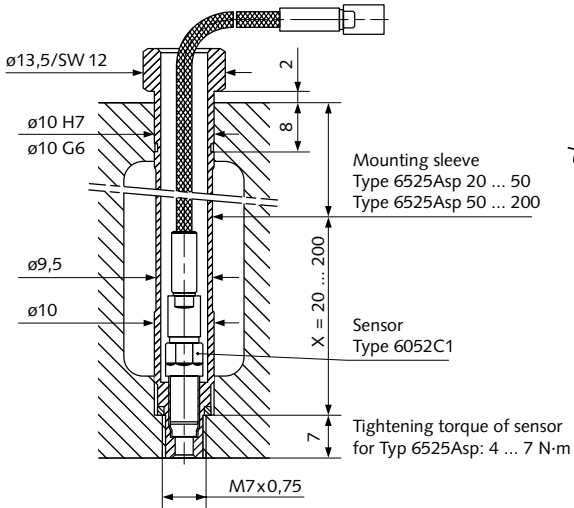

### Direct Mounting

Type 6053CC...

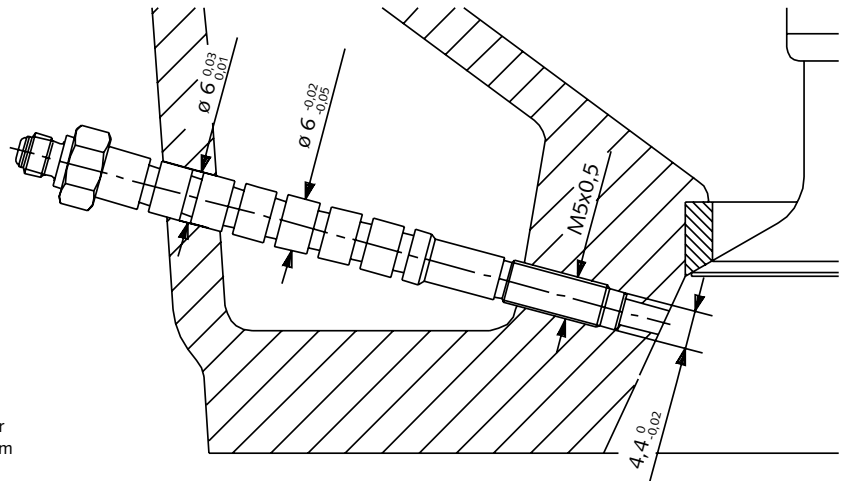

### Mounting Examples

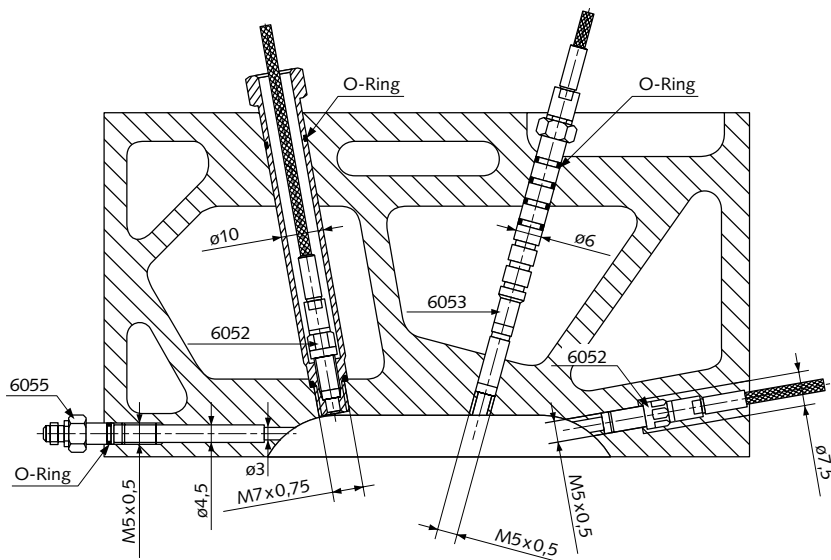

### Utilizing M5 Sensors

Uncooled miniature sensors featuring M5 mounting threads are ideal for multi-valve engines with small combustion chambers. The most effective heat dissipation is achieved by mounting with front sealing, either within a mounting sleeve or directly in the cylinder head.

Types 6053CC... and 6055C... can be used without an additional mounting sleeve in water-cooled engines. Type 6054AR... is particularly well suited for high speeds, as it is less sensitive to vibration.



## Piezoelectric Sensors

### Miniature Sensors and Measuring Probes

4,4 mm measuring probe  
standard length PiezoStar®

4 mm measuring probe  
standard length PiezoStar®

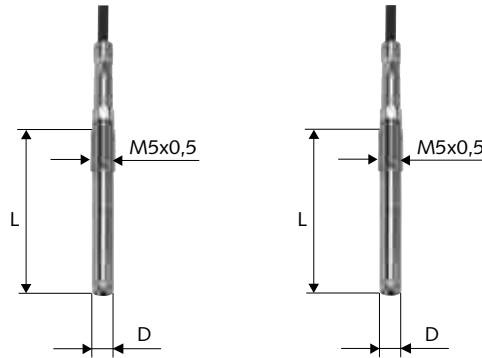

Technical data		Type 6056A...	Type 6058A...
Measuring range	bar	0 ... 250/... 300*	0 ... 250
Sensitivity	pC/bar	-20	-17
Natural frequency	kHz	≈160	≈160
Linearity	%FSO	≤±0,3	≤±0,3
Temperature range	°C	-20 ... 350	-20 ... 350
<b>Sensitivity change</b>			
200 °C ±50 °C	%	≤±0,5	≤±0,5
23 ... 350 °C	%	≤±2	≤±2
<b>Thermal shock error at 9 bar p<sub>mi</sub> (1500 1/min)</b>			
Δ p (short term)	bar	≤±0,5	≤±0,5
Δ p <sub>mi</sub>	%	≤±2	≤±2
Δ p <sub>max</sub>	%	≤±1	≤±1
<b>Dimensions</b>			
D	mm	4,4	4
L	mm	33,5	33,5
<b>Characteristics</b>		As for Type 6052C... . Thread set back, M3 cable connection. Only requires 4,5 mm mounting hole. Suitable for measurements with glow plug adapter Type 6542Q... from 5 mm diameter. Direct mounting in confined spaces.	Probe with thread set back, M3 cable connection. Only requires 4,1 mm mounting hole. Suitable for measurements with glow plug adapter Type 6544Q... from 4,5 mm diameter. Direct mounting in confined spaces.
<b>Data sheet</b>		6056A_000-529	6058A_000-573

### Mounting bore

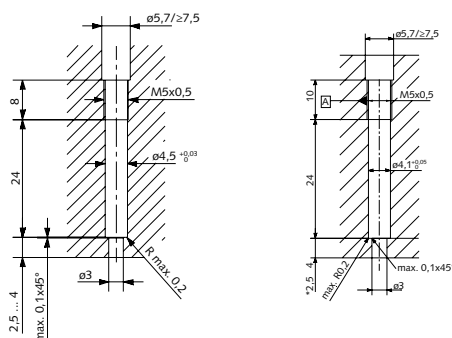

\*...U20 version (with reinforced diaphragm)

# Measuring

## Mounting in Glow Plug Adapters

Type 6056A...  
in adapter Type 6542Q...

Type 6058A...  
in adapter Type 6544Q...

Type 6056A...  
in adapter Type 6542Q...



## What to Specify for the Adapter Design

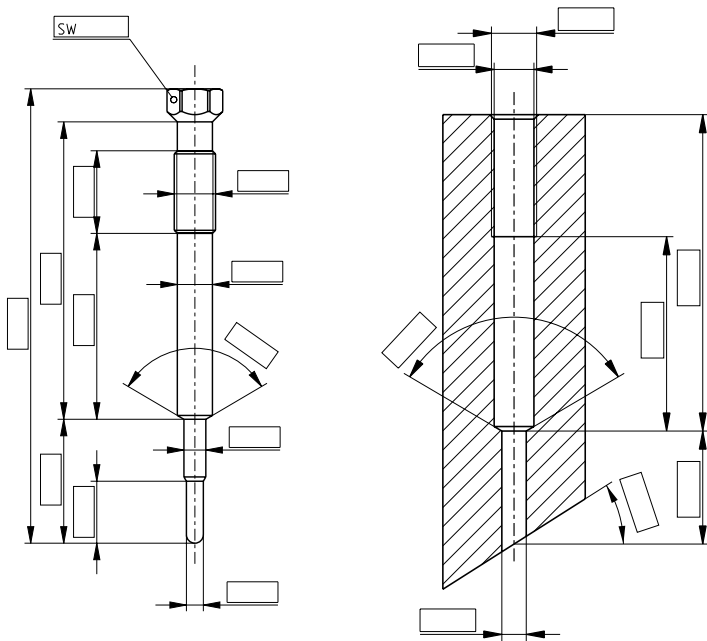

Glow plug adapters allow measurement of cylinder pressure without an expensive separate measuring bore.

- Simplest method of mounting without additional indicating bore
- Design conforming to specified glow plug bore
- High signal quality achieved through measurement close to the combustion in DI diesel engines
- Standard sensor for variety of glow plug adapters
- No reworking of glow plug bore necessary

As the gap between the adapter and the mounting bore influences the effectiveness of the measurement, when ordering, please specify the dimensions of both the existing glow plug and the mounting bore.

Note: Kistler cannot guarantee signal quality and service life unless accurate **mounting bore** dimensions are provided.

## Piezoelectric Sensors

### Miniature Sensors

M8 sensor PiezoStar®

4 mm measuring probe

Ground isolated PiezoStar®

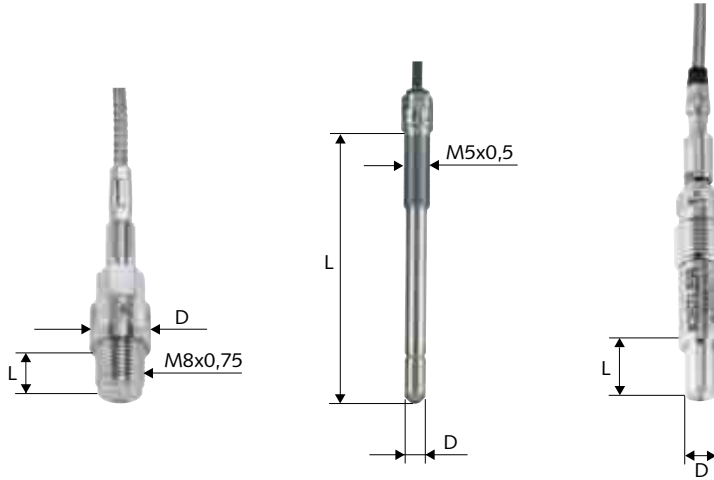

Technical data		Type 6045A...	Type 6081A...	Type 6125C...
Measuring range	bar	0 ... 250/300*	0 ... 250	0 ... 300*
Sensitivity	pC/bar	-45	-9,5	-37
Natural frequency	kHz	≈80	≈120	≈75
Linearity	%FSO	≤±0,4	≤±0,5	≤±0,4
Temperature range	°C	-20 ... 350	-20 ... 200	-20 ... 350
<b>Sensitivity change</b>				
250 °C ±100 °C	%	≤±0,7	≤±1 (200 ±50 °C)	≤±1
23 ... 350 °C	%	≤±2	≤±2 (23 ... 200 °C)	≤±2
<b>Thermal shock error at 9 bar p<sub>mi</sub> (1500 1/min)</b>				
Δ p (short term)	bar	≤±0,3	≤±0,8	≤±0,3
Δ p <sub>mi</sub>	%	≤±1,5	≤±4	≤±1,5
Δ p <sub>max</sub>	%	≤±1	≤±2	≤±1
<b>Dimensions</b>				
D	mm	9,8	4	6,2
L	mm	7,9	30 ... 80 (available)	10
<b>Characteristics</b>		High-temperature sensor, non-cooled, shoulder-sealing, mounting bore M8x0,75, mounting dimensions compatible with Type 6041A..., high sensitivity, low thermal sensitivity drift, long life, very low thermal shock error.	Miniature sensor for pressure measurements, easily installed and robust, available in different lengths, 90° taper for flexible mounting.	High-temperature sensor with special mounting sleeve. Ground isolation allows interference-free measurement even where potential differences arise. Low thermal sensitivity drift. Very low thermal shock error with high sensitivity.
<b>Data sheet</b>		6045A_000-618	6081A_000-494	6125C_000-695

### Mounting bore

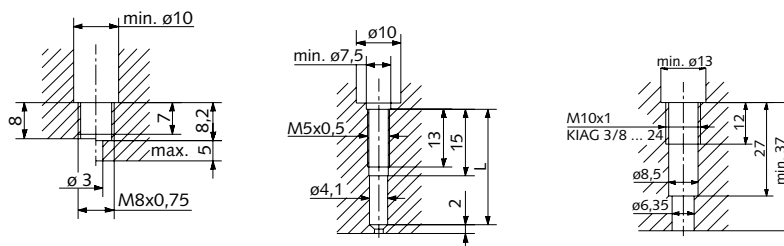

\*...U20 version (with reinforced diaphragm)



# Measuring

## Mounting Examples

Type 6081A...

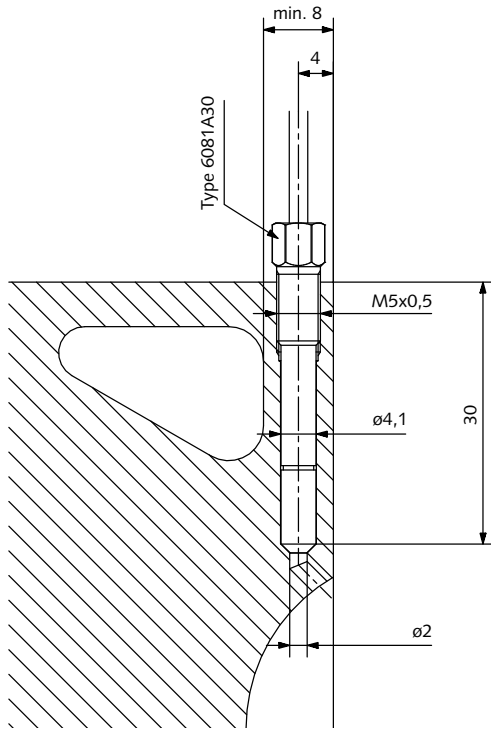

## Mounting Examples

Type 6125C...

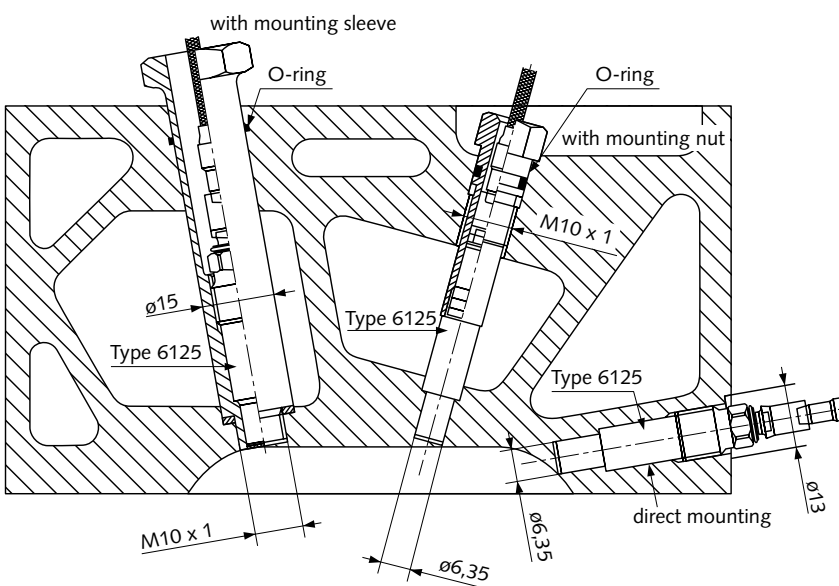

## Thermal Shock

Thermal shock, which is also called short-term drift, is a measuring error arising periodically within each combustion cycle. It is caused by time-dependent thermal stresses in the sensor diaphragm induced by the heat flux of hot combustion gases, which can reach temperatures of over 2 000 °C for a few milliseconds.

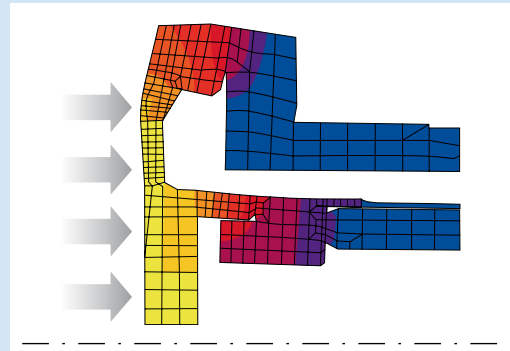

FEM simulation shows on a highly magnified scale deformation of the diaphragm (left) under the influence of heat flux

The deformation of the diaphragm creates the illusion of a change in pressure. The degree of falsification of the measurement result depends on the sensor, its mounting arrangement and the operating point of the engine. Thus, in a given engine the error depends on the injection/ignition point, speed, load, etc.

The magnitude of thermal shock is measured relative to a water-cooled reference pressure sensor whose low temperature error makes it ideal for precision thermodynamic measurements. The thermal shock corresponds to the maximum deviation between the unit under test and the reference sensor. The values relate to measurements in a test engine at 1 500 1/min and at an IMEP of 9 bar.

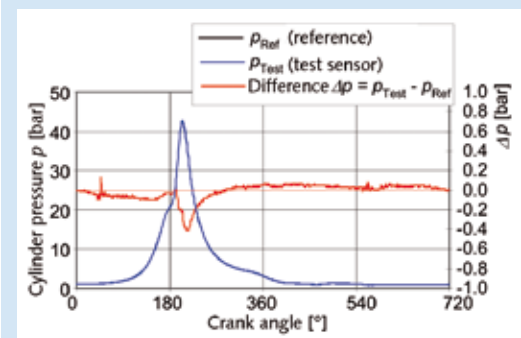

Short-term drift of miniature sensor measured on Kistler test engine

## Piezoelectric Sensors

### Sensors and Probes, Water-cooled

M8 sensor  
ThermoComp®

M8 probe  
ThermoComp®

M10 ThermoComp®  
quartz pressure sensor

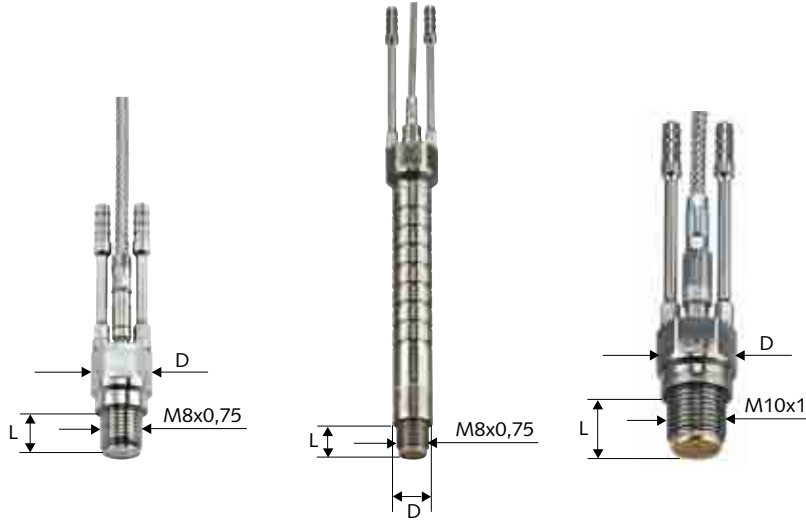

Technical data	Type 6041B...	Type 6043A...	Type 6061B...	
Measuring range	bar	0 ... 250	0 ... 250/... 300*	0 ... 250/... 300*
Sensitivity	pC/bar	-40	-20	-25
Natural frequency	kHz	≈70	≈70	≈90
Linearity	%FSO	≤±0,3	≤±0,5	≤±0,5
Temperature range	°C	-20 ... 350	-20 ... 350	-20 ... 350
<b>Sensitivity change</b>				
50 °C ±35 °C (cooled)	%	≤±0,5	≤±0,5	≤±0,5
23 ... 350 °C (uncooled)	%	≤±2	≤±2	≤±2,5
<b>Thermal shock error at 9 bar p<sub>mi</sub> (1500 1/min)</b>				
Δ p (short term)	bar	≤±0,25	≤±0,25	≤±0,2
Δ p <sub>mi</sub>	%	≤±1	≤±2	≤±1
Δ p <sub>max</sub>	%	≤±1	≤±1	≤±1
<b>Dimensions</b>				
D	mm	11,5	9,8	13,5
L	mm	7,9	8	10
<b>Characteristics</b>				
	Smallest water-cooled sensor with M8 thread, excellent thermal drift stability due to water cooling. Double diaphragm with optimized thermal shock resistance, long life steel-sheathed cable.	Probe for direct mounting in 10,0 mm hole. Excellent thermal drift stability due to water cooling. Double diaphragm with optimized thermal shock resistance, long life due to TiN coating and steel-sheathed cable.	Water cooled sensor with M10 thread, excellent thermal drift stability due to water cooling. Double diaphragm with optimized thermal shock resistance, long life due to TiN coating and steel-sheathed cable.	
<b>Data sheet</b>				
	6041B_000-516	6043A_000-014	6061B_000-020	
<b>Mounting bore</b>				

\*...U20 version (with reinforced diaphragm)

## Mounting Examples

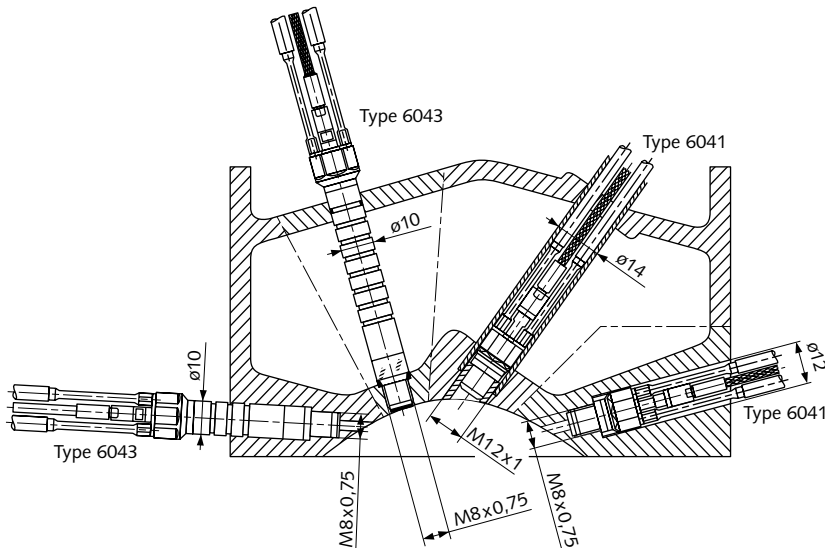

## ■ Tips for Care of Cylinder Pressure Sensors

Quartz cylinder pressure sensors must be cleaned at regular intervals depending on the type of application, service period and fuel being used. Any deposits can be removed as specified in the following instructions.

**Note: The cable must be left connected to the sensor during cleaning or a cap Type 1895... fitted to the sensor connector.**

### 1. Rough cleaning

Remove the layer of dirt (consisting of fuel residues, soot and lubricating oil) deposited on the diaphragm with a mild abrasive agent (such as Kistler polishing rubber (grade 240), Type No. 6.970.010).

**Note: Never clean the front of the sensor with metallic agents (for example, by brushing, grinding, scraping or sand blasting), as this can irreparably damage the diaphragm and hence the sensor.**

### 2. Thorough cleaning

We recommend dipping the sensor in a cleaning agent based on a mineral oil (e.g. petroleum ether, petrol), cleaned with a brush and then dried with compressed air. Kistler's Type 1003 cleaning spray may be used for this task.

### 3. Thorough cleaning in ultrasonic bath

If necessary, a thorough cleaning of the sensors can be achieved using an ultrasonic bath, however it is imperative to ensure:

- The connecting cable is properly tightened
- The sensor is immersed in the cleaning agent up to its seal ring only
- The cleaning time does not exceed 2 minutes

**Note: Cleaning for too long and use of excessively powerful ultrasonic baths can irreparably damage the sensor.**

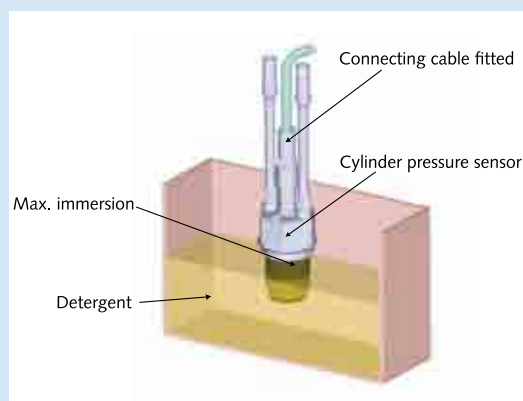

## Piezoelectric Sensors

### Sensors, Water-cooled

ø10 mm ThermoComp®  
pluggable pressure sensor

M14 ThermoComp®  
quartz pressure sensor

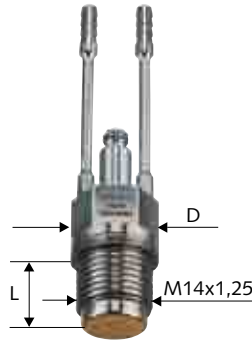

Technical data		Type 6067C...	Type 7061B...
Measuring range	bar	0 ... 250/... 300*	0 ... 250
Sensitivity	pC/bar	-25	-80
Natural frequency	kHz	≈90	≈45
Linearity	%FSO	≤±0,3	≤±0,5
Temperature range	°C	-20 ... 350	-20 ... 350
<b>Sensitivity change</b>			
50 °C ±35 °C (cooled)	%	≤±0,5	≤±0,5
23 ... 350 °C (uncooled)	%	≤±2	≤±2
<b>Thermo shock error at 9 bar p<sub>mi</sub> (1500 1/min)</b>			
Δ p (short term)	bar	≤±0,2	≤±0,1
Δ p <sub>mi</sub>	%	≤±1	≤±0,5
Δ p <sub>max</sub>	%	≤±1	≤±0,5
<b>Dimensions</b>			
D	mm	9,9	16
L	mm	9,5	13
<b>Characteristics</b>		As Type 6061B... . Special mounting sleeve for easy mounting and removal of sensor.	Water-cooled sensor with extremely high sensitivity, excellent thermal drift stability due to water cooling. Double diaphragm with optimized thermal shock resistance, long life due to TiN coating and steel-sheathed cable. Reference sensor.
<b>Data sheet</b>		6067C_000-021	7061B_000-052

### Mounting bore

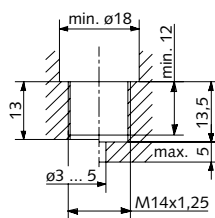
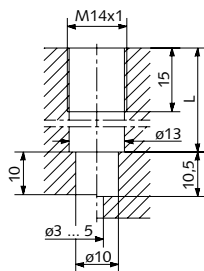

\*...U20 version (with reinforced diaphragm)



# Measuring

## Sleeve

Type 6067C...

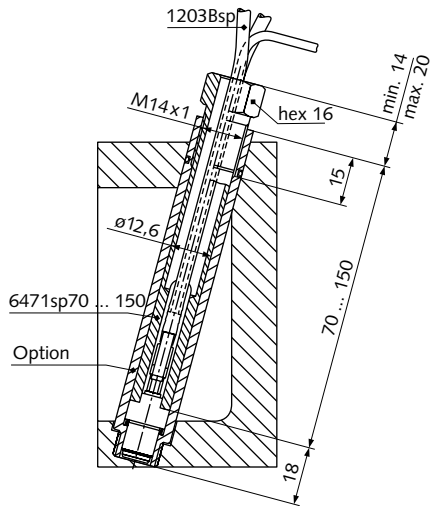

## Accessories for Mounting Sensors

The method of mounting the sensor heavily influences measurement quality and sensor life. It is therefore very important to strictly follow the various tolerances and surface finish requirements for the indicating bores in addition to the torque wrench settings for tightening the sensors.

Kistler offers an extensive range of tools for forming the bores and threads, installing the sensors and finishing the sealing surfaces. Careful preparation using the correct tools and adapters will ensure a high quality of data and the longest sensor life.

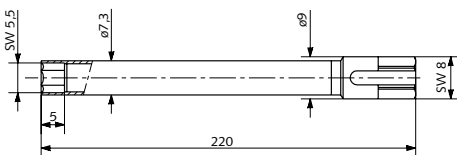

Mounting wrench SW 5,5 Type 1300A9

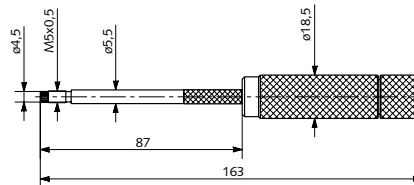

Finishing tool for bore Type 1300A79

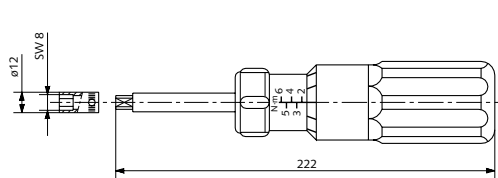

Torque wrench 1 ... 6 N-m Type 1300A17

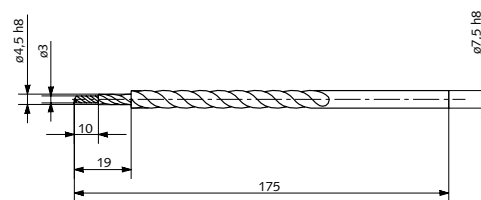

Step drill Type 1300A51

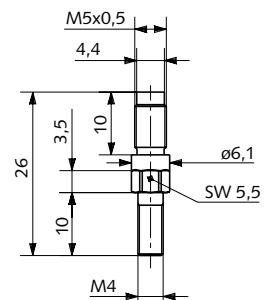

Dummy sensor Type 6445  
(for Type 6052...)

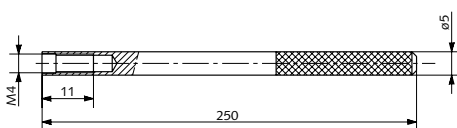

Extraction tool for dummy sensor Type 1319

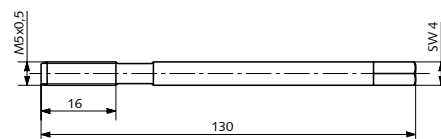

Special tap M5x0,5 Type 1357A

## Measuring Spark Plugs

M10x1 with integral cylinder pressure sensor



M12x1,25 with integral cylinder pressure sensor

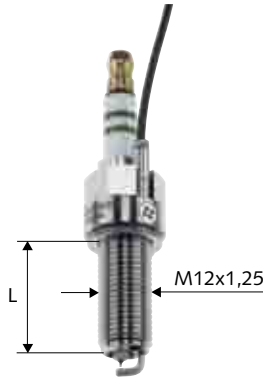

M14x1,25 with integral cylinder pressure sensor



M14x1,25 with integral cylinder pressure sensor

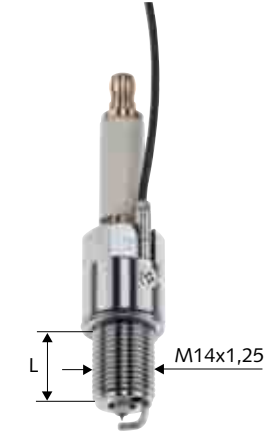

Technical data	Type 6113B...	Type 6115B...	Type 6117B...	Type 6118B...
Measuring range	bar	0 ... 200	0 ... 200	0 ... 200
Sensitivity	pC/bar	-10	-10	-15
Natural frequency	kHz	≈130	≈130	≈130
Linearity	%FSO	≤±0,5	≤±0,5	≤±0,5
Temp. range (sensor)	°C	-20 ... 200	-20 ... 200	-20 ... 200
<b>Sensitivity change</b>				
200 °C ±50 °C	%	≤±0,5	≤±0,5	≤±0,5
<b>Thermal shock error</b>				
at 9 bar p <sub>mi</sub> (1 500 1/min)				
Δ p (short term)	bar	≤±0,6	≤±0,6	≤±0,6
Δ p <sub>mi</sub>	%	≤±3	≤±3	≤±3
Δ p <sub>max</sub>	%	≤±1,5	≤±1,5	≤±1,5
<b>Dimensions</b>				
Sealing flat	L mm	19/22/26,5	19/26,5	19/22/26,5
Sealing tapered	L mm	-	-	17,5/23,5/25,4
<b>Characteristics</b>				
		M10 measuring spark plug with integral sensor. High natural frequency, front of sensor flush, replaceable ceramic insulator, with platinum electrodes. Reduced center electrode eccentricity of 1,6 mm.	M12 measuring spark plug with integral sensor. High natural frequency, front of sensor flush, wide range of spark plugs available. Replaceable ceramic insulator. Replaceable cable. Reduced center electrode eccentricity of 1,7 mm.	M14 measuring spark plug with integral sensor. High sensitivity and natural frequency, front of sensor flush. Replaceable cable. Eccentricity 2,2 mm.
<b>Data sheet</b>		6113B_000-732	6115B_000-697	6117B_000-022
<b>Mounting bore</b>				

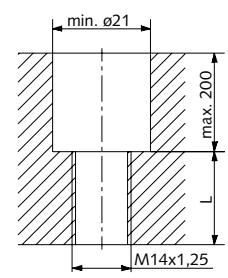
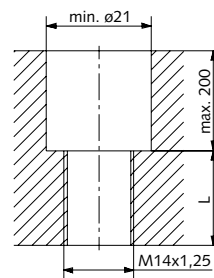
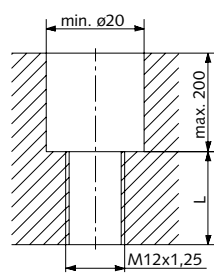
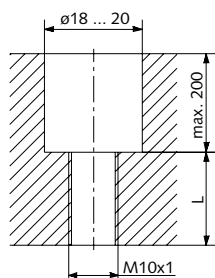

# Measuring

## Measuring Spark Plugs

Measuring spark plugs allow cylinder pressure measurement without any separate indicating bore. The spark plug contains the smallest piezo-electric high-temperature cylinder pressure sensor available in the world.

The sensor is positioned flush with the combustion chamber, giving a natural frequency of more than 50 kHz. The measuring spark plug is thus ideal for pressure indication measurements on internal combustion engines running at high speeds.

The heat value defines the range of applications of the spark plug. Hot plugs (10, 8) are used in standard engines, which often operate lightly loaded. Cold plugs (03, 07) are used for high-performance engines under high loads.

The Kistler measuring spark plugs use the BERU/BOSCH heat values:

New	10	9	8	7	6	5	4	3	09	08	07
	Hot			Medium				Cold			

Different manufacturers define the heat values in different ways. A comparison table therefore has to be used to specify the corresponding heat values. The original heat value should be used if possible. A spark plug can be replaced with a colder but not a hotter plug.

This means a spark plug with a heat value of 6 can be replaced with a plug with a heat value of 5, but not vice versa.

## Overview of Heat Values

DENSO	NGK	Champion	BOSCH
9	2	18	10
14	4	16, 14	9
16	5	12, 11	8
20	6	10, 9	7,6
22	7	8,7	5
24	8	6, 61, 63	4
27	9	4, 59	3
29	9,5	57	
31	10	55	2
32	10,5	53	
34	11		09
35	11,5		07

Installing spark plugs with the wrong heat value, thread reach or sealing seat generally has serious consequences for the engine, its operating characteristics and the plugs themselves.

Table comparing the heat values of different spark plug manufacturers.

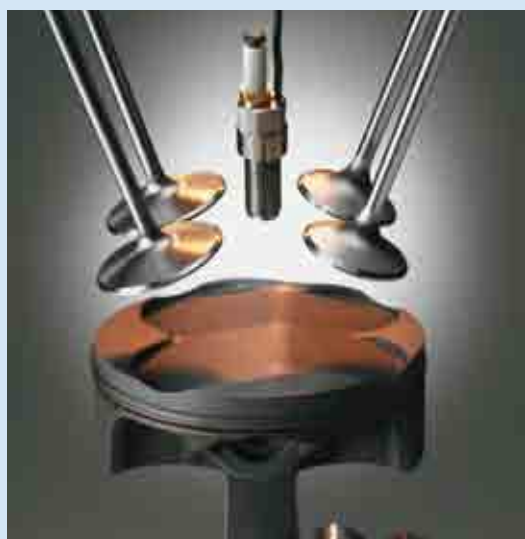

## Installing Spark Plugs

Thread	Torque in N·m Cylinder head	
	Cast iron	Aluminum
<b>Flat Seal</b>		
M12x1,25	15 ... 25	12 ... 20
M14x1,25	20 ... 35	15 ... 30
M18x1,5	30 ... 45	20 ... 35
<b>Tapered seal</b>		
M14x1,25	15 ... 25	12 ... 20
M18x1,5	15 ... 30	15 ... 25

Mounting without torque wrench:

- Flat seal: turn maximum of 90° to tighten
- Tapered seal: tighten approximately 15°

## Piezoresistive Sensors

### M5 Miniature Absolute Pressure Sensor/Measuring Chain

M5 sensor

M5 sensor with temperature range up to 200 °C

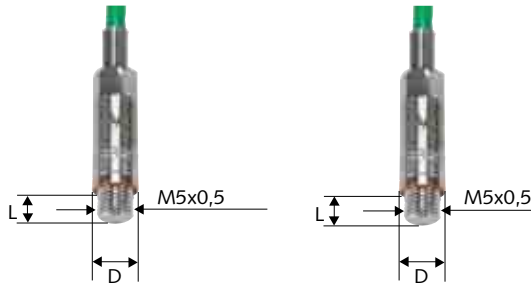

Technical data		Type 4005B...	Type 4007BA...F S
Measuring range	bar	0 ... 5/... 10/... 20/... 50/ ... 100/... 250	0 ... 5/... 20
Output signal (amplif.)	V	0 ... 10	0 ... 10
Linearity and hysteresis (BSL)	%FSO	<±0,2	<±0,2
Min./max. temperature	°C	-40/125	-40/200
Compensated temperature range	°C	0 ... 125	0 ... 180
Natural frequency	kHz	>100	>100
Material		17-4PH St. Stl.	17-4PH St. Stl.
Dimensions	D mm	6,2	6,2
	L mm	4	4
Characteristics		Miniature pressure sensor for measuring pressures in the intake systems. Compact size for versatile applications, very high natural frequency. Available as PiezoSmart version or measuring chain with amplifier Type 4618A...	Miniature pressure sensor for measuring pressures in the intake systems. Compact size for versatile applications, high natural frequency. Available as PiezoSmart version or measuring chain with amplifier Type 4618A...
Data sheet		4005B_000-594	4007B_000-614

#### Mounting bore

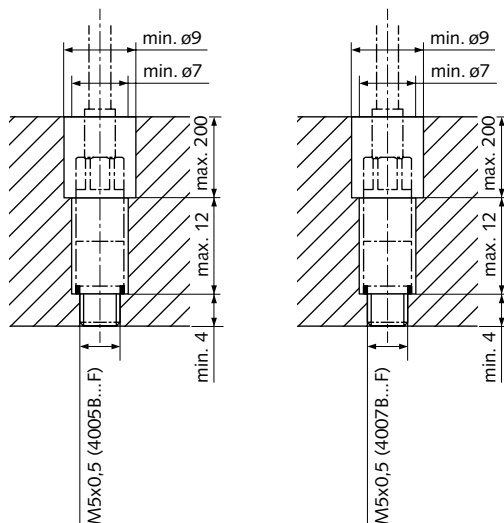

# Measuring

## Piezoresistive Sensors

### Low Pressure Indication in Combustion Engine

As modern internal combustion engines face ever tighter power, efficiency and emissions requirements, gas exchange optimization is becoming increasingly important. Gas exchange analysis based on low-pressure measurements in the inlet and exhaust is a key technique in this development work. Piezoresistive measurement technology provides a suitable solution in providing high-precision absolute pressure measurements.

Piezoresistive pressure sensors have to meet the following requirements:

- High-precision absolute pressure measurement
- Miniaturization for highly flexible mounting
- Robust construction and long service life

In addition to suitable sensors, factors such as adapters and installation for the particular application are of considerable importance.

The intake pressure can generally be measured with directly mounted sensors that are not actively cooled.



*Piezoresistive absolute pressure sensor Type 4005B... mounted in the inlet manifold*

However, high exhaust temperatures (>1 000 °C) always necessitate such cooling. Ideal cooling of water-cooled sensors or adapters is achieved with the Kistler temperature conditioning unit Type 2621E... .

A suitable low-pressure analysis system is chosen primarily on the basis of the following criteria:

- Available space
- Required accuracy
- Service stresses (heat, vibration and soot)

A fundamental distinction can be drawn between two applications:

#### Compact Solutions

Compact sensors can be positioned perfectly even when space is at a premium. These sensors are directly installed into the measuring bore or by using compact cooled adapters. This ease of handling is enhanced by other advantages such as reliability, longevity and good accuracy.

#### Highest Accuracy

Maximum accuracy is often essential if the R&D focus is on low pressure analysis. The desired precision can be achieved through the use of cooled switching adapters.

The following mounting situation shows the sensor system recommended by Kistler for both applications. Other sensors and (cooled) adapters are available.

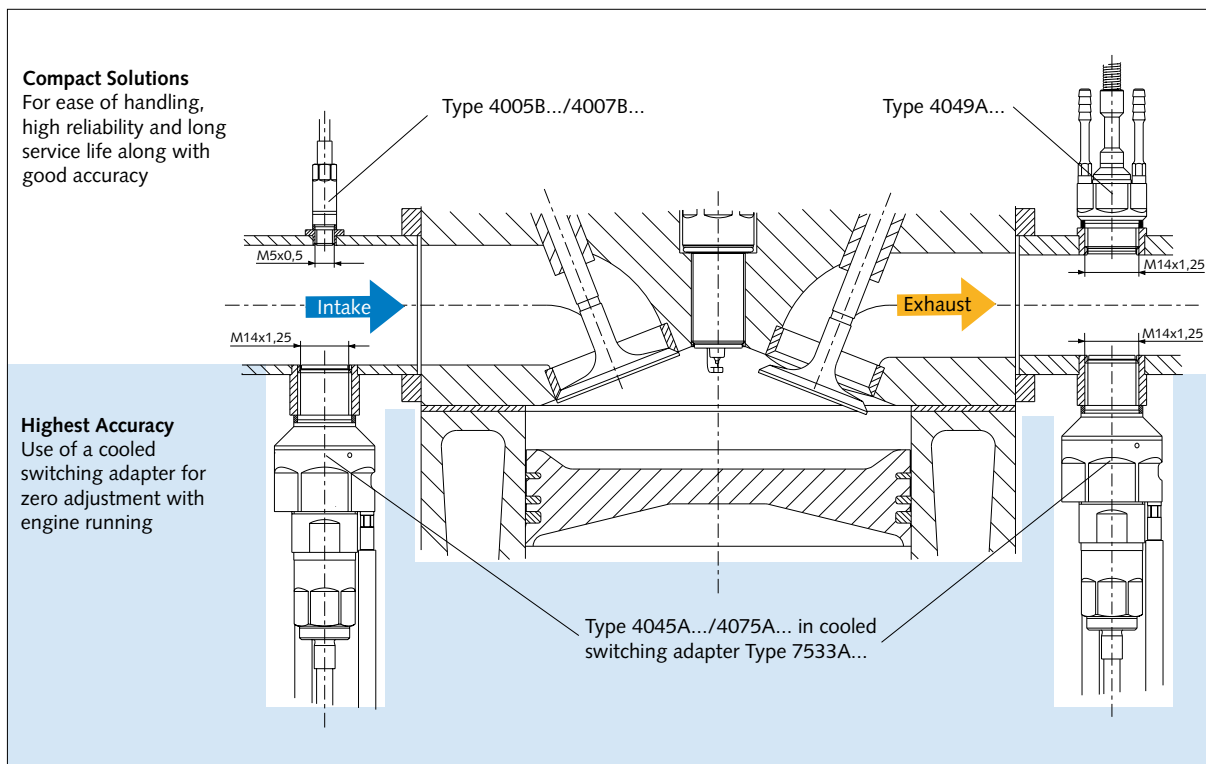



## Piezoresistive Sensors

### Absolute Pressure Sensors

M14 sensor with PiezoSmart®



M12 sensor with PiezoSmart®

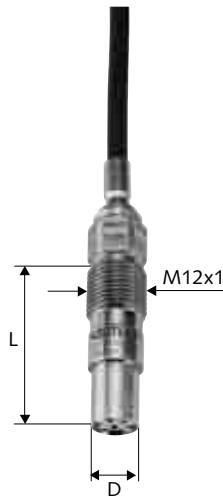

M14 sensor, water-cooled with PiezoSmart®

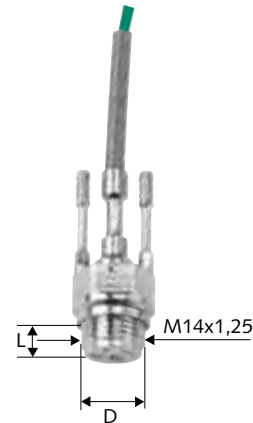

Technical data	Type 4043/45A...V200S	Type 4073/75A...V200S	Type 4049A...S
Measuring range bar (abs.)	0 ... 1/... 2/... 5/... 10/... 20/... 50/... 100/... 200/... 500	0 ... 10/... 20/... 50/... 100/... 200/... 500	0 ... 5 /... 10
Linearity and hysteresis (BSL) %FSO	<±0,3	<±0,3	<±0,1
Min./max. temperature °C	-40/70, 0/140	-40/70, 0/140	0/120 (...>1 100 °C gas temp.)
Compensated temperature range °C	20 ... 120 -20 ... 50 (Type 4043A...)	20 ... 120 -20 ... 50 (Type 4073A...)	0 ... 80
Natural frequency* kHz	>14 ... 200	>125 ... 200	>60
<b>Dimensions</b> D mm	12	9,5	18
L mm	14	35	6,7
<b>Characteristics</b>	Built-in temperature compensation, high natural frequency, good linearity. PiezoSmart version with sensor identification when used with SCP amplifier Type 4665. Also available as measuring chain Type 4618.	Built-in temperature compensation, high natural frequency, good linearity. PiezoSmart version with sensor identification when used with SCP amplifier Type 4665. Also available as measuring chain Type 4618.	Compact sensor size with water cooling. Oil-filled measuring element. Steel diaphragm for media separation. Available as PiezoSmart or as measuring chain with amplifier Type 4622A....
<b>Data sheet</b>	4043A_000-003	4043A_000-003	4049A_000-727

#### Mounting bore

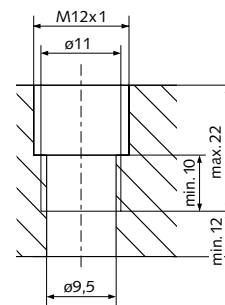
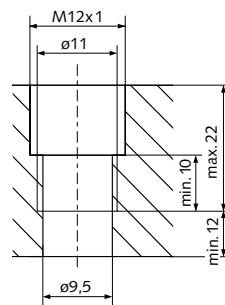
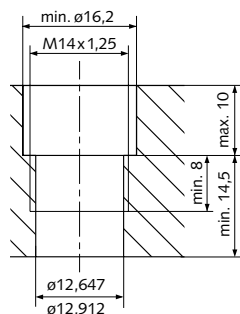

\* Depending on measuring range

# Measuring

## Piezoresistive Sensors

### Switching Adapter

Technical Data		Type 7533A...
Measuring range	bar	<15
Control air pressure	bar	2 ... 6
Switching delay	ms	<200
Coolant flow	l/min	min. 0,3
<b>Dimensions</b>	D mm	M14x1,25
	L mm	13
Weight	grams	185
<b>Characteristics</b>	Two way switching adapter with water cooling for piezo-resistive pressure sensors. To be used with: A11 Type 4045 M14y1,25 A12 Type 4075A... M12x1	
<b>Data sheet</b>	7533A_000-606	

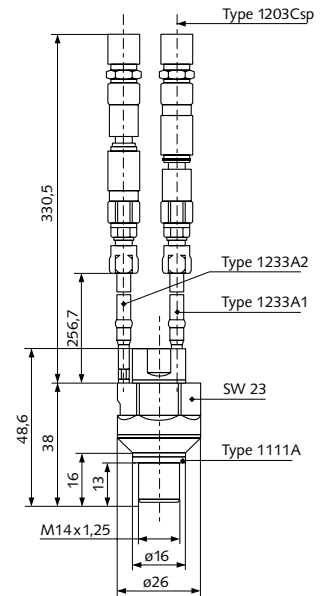
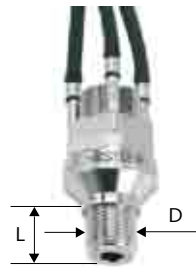

### Exhaust Pressure Measurement Using a Switching Adapter



Example of low-pressure measuring point in good position near exhaust valve. The sensor is mounted in a switching adapter

To cope with the high gas temperatures the sensors have to be actively cooled in the exhaust. The cooled switching adapter Type 7533A... provides the optional conditioning of exhaust gases which in turn yields the best sensor accuracy and longest life.

Use of the cooled switching adapter also permits simple zeroing of the sensor signal with the engine running.

For exhaust pressure measurements the sensor Type 4045A... or 4075A... in the cooling adapter Type 7533A... is recommended.

#### Principle of operation:

The pressure sensor is only exposed to the hot exhaust gas during measurement (e.g. 100 cycles). A pneumatic valve controls exposure of the sensor to exhaust gas

pressure or ambient pressure. This allows convenient zeroing of the sensor signal with the engine running immediately prior to the measurement and under identical thermal conditions.

The intermittent exposure of the sensor to hot exhaust gas makes it possible to maximize the measurement accuracy over a long service life.

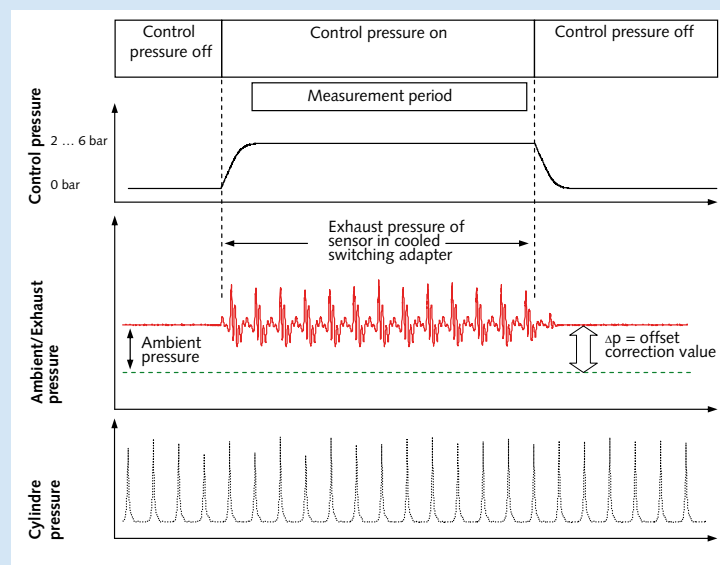

Typical measuring cycle

## Piezoresistive Sensors

### High-pressure Sensors/Measuring Chains

M10 sensor  
up to 5 000 bar  
with PiezoSmart®

M7 sensor with amplifier  
(measuring chain)  
up to 1 000 bar

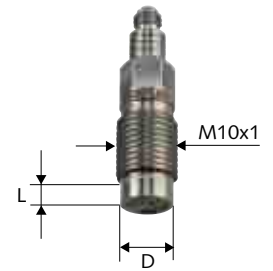
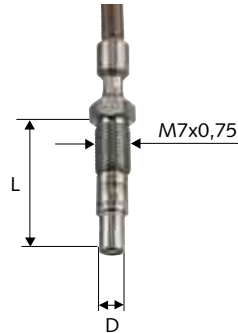
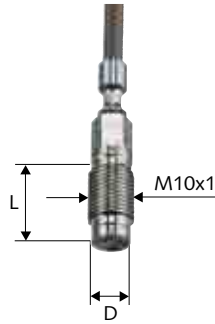

Technical data		Type 4067...	Type 4065A...
Measuring range	bar (abs.)	0 ... 1 000/... 2 000/ ... 3 000/... 5 000	0 ... 200/... 500
Output signal (amplifier)	V	0 ... 10	0 ... 10 (or 4 ... 20 mA)
Linearity and hysteresis (BSL)	%FSO	<±0,5	<±0,5
Min./max. temperature	°C	0/120	20/120
Compensated temperature range		20 ... 120	20 ... 120
Natural frequency*	kHz	>100 ... 200	>40 ... 100
Dimensions (sensor)	D mm	8,5	5
	L mm	18,6	25,3
<b>Characteristics</b>			
		High-pressure sensor with robust membrane and front sealing for measurements in hydraulic systems. Available as PiezoSmart version with sensor identification or measuring chain with amplifier Type 4618A...	High-pressure sensor with robust membrane and front sealing for measurements in hydraulic systems. Available as PiezoSmart version with sensor identification or measuring chain with amplifier Type 4618A...
<b>Data sheet</b>		4067_000-006 4067C_000-708	4065A_000-005

### Mounting bore

\* depending on measuring range

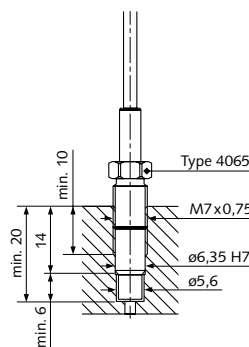
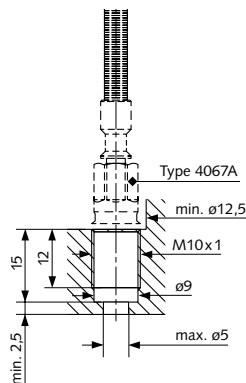

## Piezoelectric Sensors

### High-pressure Sensors

M10 sensor  
up to 5 000 bar

Technical data		Type 6229A...
Measuring range	bar	5 000
Overload	bar	6 000
Natural frequency	kHz	≈200
Linearity	%FSO	<±1
Sensitivity	pC/bar	-2,5
Calibration		Kistler Factory
Dimensions (sensor)	D mm	8,5
	L mm	4,1
<b>Characteristics</b>		
		Front sealing high-pressure sensor for pressure measurements up to 5 000 bar. The measuring characteristics of this sensor make it ideal for use measuring high dynamic fluid behaviour such as fuel injection or hydraulic pressures.
<b>Data sheet</b>		6229A_000-044

### Mounting bore

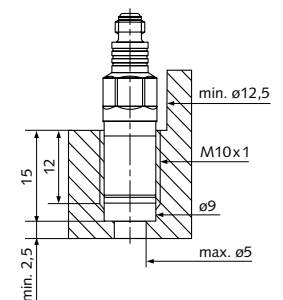

# Measuring

## Piezoresistive Sensors

### Clamping Adapters

Type 6533A1...

Type 6533A2...

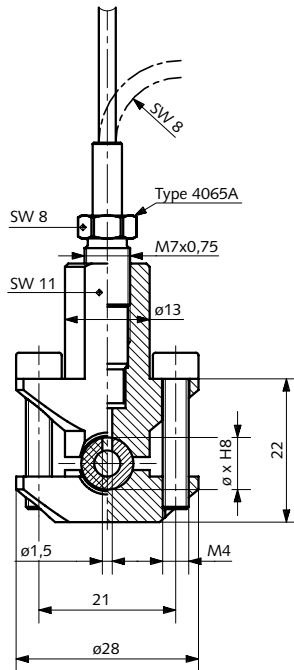
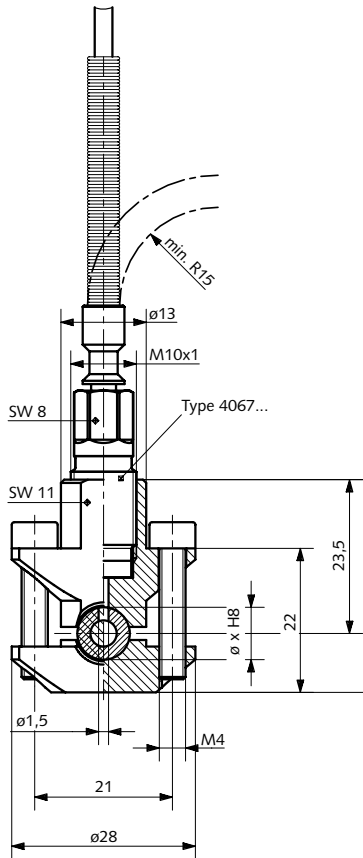

### Using and Mounting Clamping Adapters

The clamping adapter Type 6533A... is mounted on a straight section of the fuel line.

Ideally a straight, separate section of pipe allows the adapter to be easily installed. When not required, the adapter can then be replaced with an unmodified section.

Use a 1,5 mm diameter bit to drill into the fuel pipe through the mounted adapter. This operation must be done at high speed to minimize the size of the metallic residue. Avoid damaging the opposite wall of the fuel pipe!

The adapter must remain on the fuel pipe and cannot be removed and remounted. After drilling,

it is advisable to flush the pipe to remove all of the metallic residue.

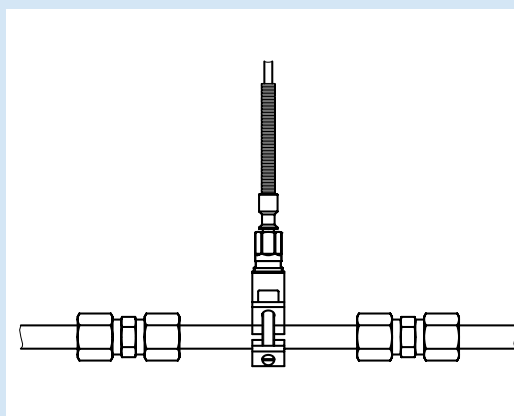

### Sensor vs. Adapter

6533A... Adapter	Sensor Type	4045A...	4065A...	4067A.../6229A...	4005B...	6052C...
1						
2			•			
4		•				
5						•
7					•	

The table shows which adapter is suitable for which sensor. For example, sensor Type 4067A... is used with adapter Type 6533A1... .

## Piezoresistive Sensors

### General Purpose High Performance Pressure Transducer

Rugged absolute sensor  
customer configurable

Gage sensor,  
wide temperature range  
with integral amplifier

Compact differential  
pressure sensor













Technical data		Type 4260A...	Type 4262A...	Type 4264A...
Measuring range	bar	1 ... 350 absolute barometric	0,1 ... 350 gage or sealed gage	0,1 ... 10 differential
Overpressure		>3 x FS	>3 x FS	>3 x FS
Output signal		mV, V or mA	mV, V or mA	mV, V or mA
Accuracy (linearity, hysteresis and repeatability)	±%BFSL	0,1 (0,05 available)	0,2 (≤1 bar) 0,1 (>1 bar) (0,05 available)	0,2 (≤1 bar) 0,1 (>1 bar) (0,05 available)
Min./max. temp.	°C	-55/125 (mV, V)	-55/125 (mV, V)	-55/125 (mV, V)
	°C	-55/80 (mA)	-55/80 (mA)	-55/100 (mA)
Compensated temperature range	°C	-40/125 (mV, V)	-40/125 (mV, V)	-40/125 (mV, V)
	°C	-40/80 (mA)	-40/80 (mA)	-40/80 (mA)
<b>Thermal effects</b>				
-5 ... 50 °C	%FS	1	1	1
-40 ... 125 °C	%FS	1,5	1,5	1,5 (for ranges below 1 bar)
Pressure connection		Customer selectable	Customer selectable	Customer selectable
Electrical connection		Customer selectable	Customer selectable	Customer selectable
<b>Dimensions</b>	D mm	25	25	25
	L mm	85	63	100
<b>Characteristics</b>		<p>Type 4260/62 and 4264 is a versatile high performance compact pressure series which offers absolute, gage and differential versions. Maximal product flexibility concerning pressure connector and electrical output configuration is given due to its high modularity.</p> <p>The unique patented sealing method enables to withstand multiple cycles without fatigue that is especially useful in cyclic applications.</p> <p>This design also enables flexibility in choice of pressure connections without the use of adapters or O-rings which refers to maximal media compatibility.</p> <p>All these reasons make the series suitable for operation in harsh test environments where temperature extremes, high vibration and shock levels are present.</p>		
<b>Data sheet</b>		4260A_000-685	4260A_000-685	4264A_000-714
<b>Information CE conformity</b>		CE-compliant to EN61326-1:2001/A1/A2, with pressure equipment directive (PED) 97/23/EG, category 1, pressure accessory		
<b>Intrinsically safe (available optional)</b>		<ul style="list-style-type: none"> <li>⊗ II 1G ia</li> <li>⊗ II 3G nL</li> <li>⊗ Class I Div I Groups A, B, C, D</li> </ul>		



# Connecting

## Cable Material PFA/Green, High-insulation, Triboelectrically Optimized, Temperature Range -55 ... 200 °C

Connecting cables				Extension cables		
						
M4 pos.	M4 pos. integral	KIAG 10-32 pos.	BNC pos.	BNC neg.	KIAG 10-32 neg.	
1651C...		1631C...	1601B...	1603B...		 BNC pos.
					1699A0,5	 KIAG 10-32 pos. integral
1655C...	1921	1635C...			1637C...	 KIAG 10-32 pos.
			1673A...			 Fischer neg. KE 103
	1985A1S1 ... **)	1985A2S1 ... **)				 10-32 Triax M4 Triax

### Materials

#### PFA/green

The characteristics of the perfluoro alkoxy alkane (PFA) cable braidings include their strength, even at very high temperatures, excellent thermal stability and superb chemical resistance. When using cables without a metal sheath, ensure they are not subjected to any mechanical loads caused by friction.



Cable PFA/green

\*\* see PiezoSmart cabling on page 45

## Cable Material PFA/Metal, High-insulation, Triboelectrically Optimized, Temperature Range -55 ... 200 °C







### Materials

#### PFA/metal

To protect the cables against mechanical damage, such as that caused by friction due to vibration, they are provided with a flexible steel or stainless steel braiding. In other respects their design corresponds to the PFA/green version with a sheath of chemical- and temperature-resistant perfluoro alkoxy alkane.



Cable PFA/metal









Connecting cables			
			
M4 pos. integral	KIAG 10-32 pos.	KIAG 10-32 pos. integral	
1929A...*)			 M4 pos. integral
		1967A... ***) 1969A...*)	 KIAG 10-32 pos. integral
1919 *) 1975A...*)	1957A...*)		 KIAG 10-32 pos.
1985A1S3... **)		1985A2S3... **)	 10-32 Triax M4 Triax

\*) with stainless steel braiding, \*\*) see PiezoSmart cabling on page 45, \*\*\*) electrically insulated stainless steel braiding

➡ Please note that the selected cable combination must match your particular sensor! For more information please refer to page 45.













# Connecting

Cable Material Viton®/Black, High-insulation, Triboelectrically Optimized, Temperature Range -55 ... 200 °C

Connecting Cables			
 M3 pos. integral	 M4 pos. integral	 KIAG 10-32 pos. integral	
	1983AA... oil resistant		 M4 pos. integral
1989A...	1927A... <sup>*)</sup>	1983AC...	 KIAG 10-32 pos. integral
	1983AB...		 KIAG 10-32 pos.
1989A...			 M3 pos. integral
1985A8S4 ... <sup>**)</sup>	1985A157 ... <sup>**)</sup>	1985A2S7 ... <sup>**)</sup>	 Triax

\*\* see PiezoSmart cables on page 45

## Couplers High-insulation (without PiezoSmart® Function)

TRIAX neg.	BNC pos.	KIAG 10-32 neg.	KIAG 10-32 pos.	M4 neg.	
 1704A1					BNC neg.
 1704A2	 1721	 1729A			KIAG 10-32 neg.
 1704A3	 1705	 1700A13	 1700A31	 1700A23	M4 neg.
 1704A5	 1706	 1700A35			M3 neg.
	 1704A4				TRIAX pos.

## Materials

### Viton®/black

Viton is a registered trademark of DuPont Performance Elastomers for a class of fluoroelastomers. The material is characterized by high thermal and chemical resistance, particularly to hydrocarbons. The cables fitted with a liquid-tight connector are extremely robust and resist oils and fuels.



Viton®/black

## Criteria for Selecting Right Cable

The electrical connection between piezoelectric sensor and charge amplifier has to be highly insulated (approximately  $10^{13} \Omega$ ) to prevent electrical drift of the measurement signal. Special coaxial cables have a conductor insulated with Teflon® or Kapton® and similar requirements apply to the plug-in connections. As only very small currents flow in the cables, they are particularly prone to electrical interference and should be kept as short as possible.

## Triboelectric effect

Movement of the cables produces very small charges (triboelectric effect), which falsify the measurement. This is prevented with special cable layers coated with graphite. Typical values of the triboelectricity of special cables subjected to high levels of vibration are less than 1 pC. The cables must nevertheless be routed so they are not subject to vibration. This is particularly important with the internal combustion engine, as a cable can shake excessively if routed with too much slack.

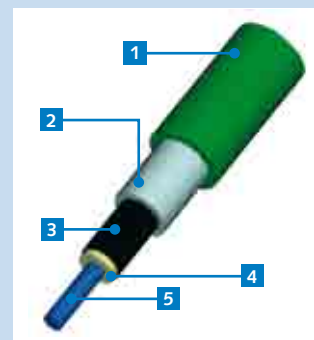

- 1 Outer insulation
- 2 Electrical shielding
- 3 Special coating (graphite conductor)
- 4 Electrical insulation Teflon® PTFE
- 5 Inner wire

# Connecting

## Cable Overview

### Piezoelectric Cables

Type	Used for sensor Type	Connection	Illustration	Connection
1603B...	–	BNC neg.		BNC pos.
1631C...	6053, 6055, 6125	KIAG 10-32 pos.		BNC pos.
1635C...	6053, 6055, 6125	KIAG 10-32 pos.		KIAG 10-32 pos.
1637C5	6053, 6055, 6125	KIAG 10-32 pos.		KIAG 10-32 neg.
1651C...	–	M4 pos.		BNC pos.
1655C...	–	M4 pos.		KIAG 10-32 pos.
1699A	6125, 7061	KIAG 10-32 pos. Int.		KIAG 10-32 neg.
1919	6041A, 6043, 6045, 6061, 6067	M4 pos. Int.		KIAG 10-32 pos.
1921	6041A, 6043, 6045, 6061, 6067	M4 pos. Int.		KIAG 10-32 pos.
1929A...	6041A, 6043, 6045, 6052, 6061, 6067	M4 pos. Int.		M4 pos. Int.
1957A...	6053, 6055	KIAG 10-32 pos.		KIAG 10-32 pos.
1967A...	6125	KIAG 10-32 pos. Int.		KIAG 10-32 pos. Int.
1969A...	7061	KIAG 10-32 pos. Int.		KIAG 10-32 pos. Int.
1975A...	–	M4 pos.		KIAG 10-32 pos. Int.
1989A4	6041B, 6054, 6056, 6058	M3 pos. Int.		M3 pos. Int.

### PiezoSmart® Cable

#### Plug Connection

M4 (pos.)	1
KIAG 10-32 (pos.)	2
M3 (pos.)	8

#### Cable Version

PFA metal braiding with PiezoSmart coupling	3
Viton® with PiezoSmart coupling	4
PFA with PiezoSmart coupling	6
Viton® oil-resistant with PiezoSmart coupling	7

#### Cable Length

1 m	1
2 m	2
sp.	9

#### TEDS Data

without factory calibration	0
According to sensor serial number with stored factory calibration data	1

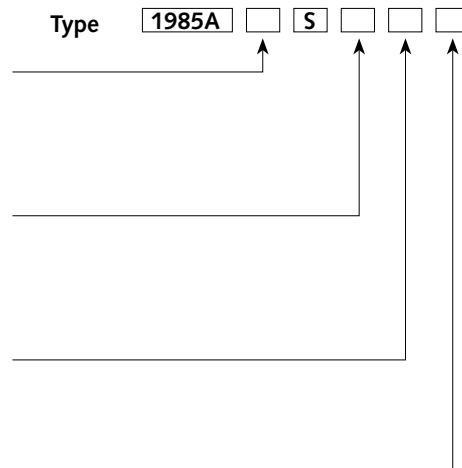



















More information about PiezoSmart is given in system description doc. no. 100-421

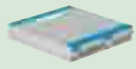

### Piezoresistive Cable

Type	Used for sensor Type	Connection	Illustration	Connection
4751A...	4043, 4045, 4053	Fischer SE		for Type 4603
4753A...	4073, 4075	Fischer SE		for Type 4603
4757A...	4065, 4067, 4005BA..., 4007BA...	Extension for Type 4065, 4067		for Type 4618
4761B...	4043, 4045, 4053, 4007B...S, 4049A...S	Fischer SE		for Type 4603, 4665
4763B...	4073, 4075, 4005B...V200S	Fischer SE		for Type 4603, 4665
4765A...	4043, 4045, 4053	Fischer SE		for Type 4618
4767A...	4073, 4075	Fischer SE		for Type 4618

## Multichannel Amplifier Systems

SCP/SCP Compact/SCP Slim							
Module	Charge amplifier	Piezoresistive amplifiers	pMax module	Bridge amplifier	Amplifier interface	Voltage amplifier	Needle lift amplifier
Platform							
Desktop version  Type 2853A120	 Type 5064B21	 Type 4665 with PiezoSmart sensor identification	 Type 5269	 Type 5271	 Type 5613A1Q01	 Type 5227A1Q01	 Type 5247
Rack version  Type 2853A110							
Rack version  Type 2854A111	 Type 5064B22 with PiezoSmart sensor identification						
Compact  Type 2854A131							
Slim  Type 2852A...	 Type 5064B11   Type 5064B12 with PiezoSmart sensor identification	 Type 4665Y51 with PiezoSmart sensor identification	 Type 5269Y51	 Type 5271Y51			

## Single-channel Amplifier Systems

Charge Amplifier	Piezoresistive Amplifiers	
Laboratory charge amplifier	Laboratory amplifier	Analog amplifier
 Type 5018A... with drift compensation, Piezotron® input and PiezoSmart	 Type 4603B...	 Type 4618A...

## Multichannel Amplifier Systems

### SCP/Signal Conditioning Platform



Technical data			Type 2853A...	Type 2853A...Y48
Number of modules (with expansion unit)			8 (16)	8 (16)
Max. number of channels (with expansion unit)			16 (32)	16 (32)
Power supply	VAC/VDC		100 ... 240 (±10 %)	11 ... 36
Max. power consumption	W		95	80
Degree of protection acc. to EN 60529			IP40	IP40
Operating temperature range	°C		0 ... 60	0 ... 50
Weight (without measuring modules)			kg	5,6
Dimensions	Height	HE	3	3
	Width	TE	84 (19")	84 (19")
	Depth	mm	min. 400	min. 400

#### Connection

Analog output card Type 5225A1:  
D-Sub 37 pin neg.

CPU output card Type 5615  
RS-232C: D-Sub 9 pin neg.  
Digital output: D-sub 15 pin neg.

Internal CAN bus: D-Sub 9 pin pos.

#### Characteristics

Modular measuring platform (SCP) for front-end signal conditioning. Available as rack/desktop versions Type 2853A110/A120 and can be expanded with additional slave units Type 2853A010/A020.

#### Application

With the function-specific modules, measuring tasks within combustion pressure and gas exchange, as well as injection pressure and general pressure measurements are efficiently accomplished.

#### Accessories

SCP software art. no. 7.643.014  
Serial interface cable Type 1200A27  
Blank front plate Type 5700A09  
USB/RS-232C Adapter Type 2867

**Data sheet** 2854A\_000-409

### SCP Compact/Signal Conditioning Platform



Technical data			Type 2854A...
Number of modules			4/6
Max. number of channels			8/12
Power supply	VDC		10 ... 36
Max. power consumption	W		70
Degree of protection acc. to EN 60529			IP40
Operating temperature range	°C		0 ... 50
Weight (without measuring modules)			kg
			3,5
Dimensions	Height	HE	2
	Width	TE	84 (19")
	Depth	mm	min. 400

#### Connection

Analog output:  
D-Sub 37 pin neg.

CPU output RS-232C:  
D-Sub 9 pin neg.  
Digital outputs:  
D-Sub 15 pin neg.

Internal CAN bus: D-Sub 9 pin pos.

#### Characteristics

The Signal Conditioning Platform SCP Compact Type 2854A... is a modular system for conditioning a very wide variety of measurement signals. It is particularly suitable for engine pressure indication on test stands and in the vehicle.

#### Application

With the function-specific modules, measuring tasks within combustion pressure and gas exchange, as well as injection pressure and general pressure measurements are efficiently accomplished.

#### Accessories

SCP software art. no. 7.643.014  
Serial interface cable Type 1200A27  
Blank front plate Type 5700A09  
USB/RS-232C Adapter Type 2867

**Data sheet** 2854A\_000-409



## Multichannel Amplifier

### SCP Slim



Technical data		Type 2852A...
Number of modules (with expansion units)		2 (8)
Max. number of channels		4 (16)
Power supply	VDC	10 ... 36
Max. power consumption	W	20
Degree of protection acc. to EN 60529		IP40
Operating temperature range		°C 0 ... 50
Weight (without measuring modules)		kg 1,6
Dimensions	Height	HE 1
	Width	mm 220
	Depth	mm 230

#### Connection

Analog output: D-Sub 37 pin neg.  
CPU output RS-232C: D-Sub 9 pin neg.  
Digital outputs: D-Sub 15 pin neg.  
Internal CAN bus: HD68 (SCSI-3)

#### Characteristics

The Signal Conditioning Platform SCP Slim Type 2852A... is designed for in-vehicle applications, and can be expanded to 16 channels.

#### Application

With the function-specific modules, measuring tasks within combustion pressure and gas exchange, as well as injection pressure and general pressure measurements are efficiently accomplished.

#### Accessories

SCP software art. no. 7.643.014  
Serial interface cable Type 1200A27  
Blank front plate Type 5700A19  
USB/RS-232C adapter Type 2867

**Data sheet** 2852A\_000-608

### SCP/Charge Amplifiers



Technical data		Type 5064B21	Type 5064B11
Number of channels		2	2
Measuring range	pC	±100 ... 100 000	±100 ... 100 000
Output voltage	V	0 ... ±10	0 ... ±10
Frequency range	kHz	≈0 ... >200	0 ... >200
Error (0 ... 60 °C)	%	<±0,5	<±0,5
Drift (at 25 °C, DrCo off)	pC/s	<±0,05	<±0,05
Group delay time	µs	<3	<3
Suitable for		SCP/SCP Compact	SCP Slim

#### Connection

Signal input: BNC neg.  
Signal output: BNC neg.

Control, excitation and signal transmission 64 pin to DIN 41612

#### Characteristics

Microprocessor-controlled charge amplifier with digital parameter configuration and analog signal conditioning for the SCP.

#### Application

High bandwidth signal conditioning for piezoelectric engine pressure sensors.

#### Accessories

Adapter Triax – BNC pos.  
Type 1704A4

**Data sheet** 2854A\_000-409

**Data sheet** 2852A\_000-608

### SCP/Charge Amplifiers with PiezoSmart® Sensor Identification



Technical data		Type 5064B22	Type 5064B12
Number of channels		2	2
Measuring range	pC	±100 ... 100 000	±100 ... 100 000
Output voltage	V	0 ... ±10	0 ... ±10
Frequency range	kHz	≈0 ... >200	0 ... >200
Error (0 ... 60 °C)	%	<±0,5	<±0,5
Drift (at 25 °C, DrCo off)	pC/s	<±0,05	<±0,05
Group delay time	µs	<3	<3
Suitable for		SCP/SCP Compact	SCP Slim

#### Connection

Signal input: Triax  
Signal output: BNC neg.

Control, excitation and signal transmission 64 pin to DIN 41612

#### Characteristics

Microprocessor-controlled 2 channel charge amplifier with digital parameter configuration and analog signal conditioning for the SCP. With PiezoSmart sensor identification.

#### Application

High bandwidth signal conditioning for piezoelectric engine pressure sensors.

#### Accessories

Adapters  
BNC neg. – Triax Type 1704A1  
KIAG 10-32 – Triax Type 1704A2  
M4x0,35 – Triax Type 1704A3  
M3x0,35 – Triax Type 1704A5

**Data sheet** 2854A\_000-409

**Data sheet** 2852A\_000-608

## Multichannel Amplifier Systems

### SCP/Piezoresistive Amplifier with PiezoSmart® Sensor Identification



Technical data		Type 4665	Type 4665Y51
Number of channels		2	2
Gain		10 ... 270	10 ... 270
Additional gain		1 ... 10	1 ... 10
Output voltage	V	0 ... ±10	0 ... ±10
Frequency range	kHz	≈0 ... >90	≈0 ... >90
Error (0 ... 60 °C)	%	<±0,3	<±0,3
Sensor excitation	mA	1 or 4	1 or 4
Suitable for		SCP/SCP Compact	SCP Slim

#### Connection

Signal input: Fischer 5 pin  
Signal output: BNC neg.

Control, excitation and signal transmission 64 pin to DIN 41612

#### Characteristics

Microprocessor-controlled piezoresistive 2 channel amplifier with digital parameter configuration and analog signal conditioning for the SCP. This amplifier has PiezoSmart automatic sensor identification, zero adjustment at the input and adjustable low-pass filters.

#### Application

This measuring module is used for signal amplification of piezoresistive pressure sensors and is used typically for measuring injection pressure as well as the pressures in the inlet/exhaust element of combustion engines.

#### Accessories

none

**Data sheet** 2854A\_000-409

**Data sheet** 2852A\_000-608

### SCP/pMax Modules



Technical data		Type 5269	Type 5269Y51
Number of cylinder pressure channels (input for p cylinders A & B)		2	2
Input for boost pressure (pInlet)		1	1
Analog input voltage (p cylinder A, p cylinder B, pInlet)	V	1 ... ±10	1 ... ±10
Speed range	1/min	100 ... >6 000	100 ... >6 000
Frequency range with TP filter "off"	kHz	0 ... ≈17	0 ... ≈17
Resolution	bit	12	12
Threshold values for (th_pmax, th_pmin, th_pstop), per channel		3	3
Digital warning outputs		4 (2/channel)	4 (2/channel)
Digital stop outputs		1/module	1/module
Suitable for		SCP/SCP Compact	SCP Slim

#### Connection

Signal input and output (pInlet, emergency stop, etc)  
Type D-Sub 15 pin neg.

Signal input (input cylinders A & B)  
Type BNC neg.

Signal output Type BNC neg.

Control, excitation and signal transmission 64 pin to DIN 41612

#### Characteristics

For continuous monitoring and measurement of cylinder peak pressure pmax on diesel and gasoline engines. The new two-channel pMax measuring module Type 5269 offers an ideal expansion unit for the universal Signal Conditioning Platform (SCP). The SCP charge amplifiers Type 5064B... supply the pMax module with a voltage proportional to the cylinder pressure.

#### Application

When a defined threshold is reached a warning or digital emergency stop signal is generated. At the same time the amplifier supplies an output voltage proportional to the maximum cylinder pressure of the last cycle. The pMax module can be used to prevent catastrophic damage by unsafe engine conditions.

#### Accessories

none

**Data sheet** 2854A\_000-409

**Data sheet** 2852A\_000-608

## SCP/Bridge Amplifier



Technical data		Type 5271	Type 5271Y51
Number of channels		2	2
Input voltage range (differential)	V	0 ... ±10	0 ... ±10
Gain		0,5 ... 5 000	0,5 ... 5 000
Low-pass filter (Butterworth)	Hz	10/30/100/300	10/30/100/300
(second order, selectable)	kHz	1/3/10/30/100	1/3/10/30/100
Sensor excitation (bridge voltage)			
Sensor excitation voltage	V	1 ... 12	1 ... 12
Voltage error (>2,5 V)	%	<±0,1	<±0,1
Output current	mA	<50	<50
Bridge completion (amplifier internal)			
Half-bridge (completion)	Ω	10 000	10 000
Quarter-bridge (completion)	Ω	120/350/1 000	120/350/1 000
Output voltage	V	0 ... ±10	0 ... ±10
Suitable for		SCP/SCP Compact	SCP Slim

### Connection

Signal input: D-Sub 9 pin neg.  
Signal output: BNC neg.

Control, excitation and signal transmission 64 pin to DIN 41612

### Characteristics

Can be used for a broad range of application due to the stable and adjustable excitation voltage. The selectable low-pass filters and the wide frequency range make this versatile amplifier.

### Application

This module is used for signal amplification applications for strain gage sensors and piezoresistive sensors with voltage excitation but also for simple voltage amplification.

### Accessories

D-Sub connector 9 pin pos. with screw connection  
art. no. 5.510.422

**Data sheet** 2854A\_000-409  
**Data sheet** 2852A\_000-608

## SCP/Amplifier Interface



Technical data		Type 5613A1Q01
Number of channels		2
Measuring range	V	±10
Gain		1
Frequency range	kHz	0 ... >50
Error (0 ... 60 °C)	%	<±0,1
Input impedance	kΩ	>300
Output voltage	V	0 ... ±10
Power supply for ext. amplifiers	V	24

### Connection

Digital input: D-Sub 9 pin neg.  
Signal output: BNC neg.

Control, excitation and signal transmission 64 pin to DIN 41612

### Characteristics

Microprocessor-controlled amplifier with digital parameter configuration and analog signal conditioning for the SCP. This amplifier has a power supply for external amplifiers and can be controlled remotely.

### Application

Signal conditioning for 0 ... 10 V voltage signals from external amplifiers, for instance the Kistler Type 4618A...

### Accessories

none

**Data sheet** 2854A\_000-409

## SCP/Voltage Amplifier



### Connection

Signal input: BNC neg.  
Signal output: BNC neg.

Control, excitation and signal  
transmission 64 pin to DIN 41612

Technical data		Type 5227A1Q01
Number of channels		2
Input voltage range	V	0 ... ±10
Gain (adjustable)		1/2/5/10
Frequency range	kHz	0 ... >50
Error (0 ... 60 °C)	%	<±0,5
Input impedance	MΩ	10
Output voltage	V	0 ... ±10

### Characteristics

Microprocessor-controlled amplifier with digital parameter configuration and analog signal conditioning for the SCP. This amplifier has differential inputs with a common ground.

### Application

For amplifying any voltage signals.

### Accessories

none

**Data sheet** 2854A\_000-409

## SCP/Needle Lift Amplifier



### Connection

Signal input: Binder Serie 711  
Signal output: BNC neg.

Control, excitation and signal  
transmission 64 pin to DIN 41612

Technical data		Type 5247
Number of channels		2
Input voltage range (differential)	V	0 ... ±10
Gain		0,8 ... 75
Frequency range	Hz	0 ... 90 000
Sensor excitation	VDC	12
Max. current	mA	15
Output voltage	V	0 ... ±10
Output impedance	Ω	10
Suitable for		SCP/SCP Compact

### Characteristics

Microprocessor-controlled 2 channel needle lift amplifier with differential input and the possibility to power Hall-sensors. Switchable zero point compensation and auto range setting. The differential input guarantees low noise figures.

### Application

The needle lift measurement is used to determine the injection point (start, duration, end) in Diesel engines. In order to be able to measure the needle lift in injection nozzles, the needle holder in the injection nozzle must be fitted with a Hall sensor. The voltage change at the Hall sensors provides information on the movement of the injection needle. The needle lift function is a standard measurand for Diesel engine or injection system development.

### Accessories

Cable connector 4 pin Binder serie 711 art. no. 5.510.419

**Data sheet** 2854A\_000-409

## Laboratory Charge Amplifiers

### Piezoelectric Amplifier



#### Connection

Signal input: BNC neg. or Triax  
Signal output: BNC neg.

Technical data		Type 5018A...
Measuring range	pC	±2 ... 2 200 000
Frequency range	kHz	≈0 ... 200
Output voltage	V	0 ... ±10
Error (range-dependent)	%	<±0,5 (@ 10 pC <±3)
Power supply selectable	VAC	115/230
Temperature range	°C	0 ... 50
Weight	kg	2
Dimensions WxHxD	mm	105x142x253

#### Characteristics

This universal laboratory charge amplifier can be used for signal conditioning of all piezoelectric pressure sensors.  
Drift compensation for engine combustion applications; Wide measuring range; Direct signal evaluation; Liquid crystal display and menu-driven handling.

#### Application

The instrument has been designed for use in research, development, laboratory and especially for engine applications with piezoelectric sensors.

#### Accessories

Connector for remote control connection Type 1564  
RS-232C cable Type 1475A3  
RS-232C adapter Type 1469

**Data sheet** 5018A\_000-719

### Piezoresistive Amplifier



#### Connection

Signal input: Fischer D103  
Phoenix 5 pin

Voltage output: BNC neg.

Current output:  
banana-plug socket ø4 mm

Technical data		Type 4603B...
Input signals	mV	±100 ... 1 000
Sensor excitation	mA/V	4/24
Output voltage	V	±0 ... 1/2/5/10
Output current	mA	0/4 ... 20
Frequency range	kHz	0 ... >150
Error (0 ... 50 °C)	%	<±0,4
Power supply	VAC	230/115
Temperature range	°C	0 ... 50
Dimensions WxHxD	mm	94x151x195
Weight	kg	≈2

#### Characteristics

Scalable voltage output and parallel current output. The voltage output is scalable from 1 ... 10 V, depending on the measuring range of the particular sensor. In parallel there is a load independent current output of 0/4 ... 20 mA available.

#### Application

All amplifier functions can be set in response to menu prompts on the two-line high-contrast LCD display using four buttons: type of supply, calibration current (for current excited sensors), pressure measuring range, sensor sensitivity, zero offset, unit of pressure displayed (bar, Pa or psi), low-pass filters, output voltage and output current.

#### Accessories

Calibration connector  
Type 4901B...  
Upgrade interface IEEE-488  
Kistler Type 5605A...  
Upgrade interface RS-232C  
Kistler Type 5611A...

**Data sheet** 4603B\_000-291



## Single-channel Amplifier Systems

### Piezoresistive Amplifier, for Measuring Chains



Technical data		Type 4618A0	Type 4618A2	Type 4618A4
Input signals	mV	±50 ... 1 000	±50 ... 1 000	±50 ... 1 000
Sensor excitation	mA	1,5	1,5	1,5
Output voltage	V	0 ... ±10	0 ... ±10	–
Output current	mA	4 ... 20	–	4 ... 20
Frequency range	kHz	0 ... >40	0 ... >40	0 ... >40
Error (0 ... 60°)	% FSO	±<0,2	±<0,2	±<0,2
Supply voltage	VDC	18 ... 30	18 ... 30	18 ... 30
Temperature range	°C	0 ... 60	0 ... 60	0 ... 60
Dimensions WxHxD	mm	98x34x64	98x34x64	98x34x64
Weight	kg	0,25	0,25	0,25
Temperature output	mV/°K	–	10	10

#### Connection

Binder connector

#### Characteristics

Analog amplifier for piezoresistive sensors with two limit switches (optocouplers). Zero adjustment via access on amplifier.

#### Application

Universal measuring amplifier for piezoresistive sensors with constant current supply. Allows simultaneous measurement of pressure and temperature with the standard pressure sensors. Mounted in robust aluminum case, suitable for industrial applications and in-line operation.

#### Accessories

Power adapter Type 5779A1

**Data sheet** 4618A\_000-293

## Systems for Combustion Analysis for In-Vehicle Applications

### KiBox® To Go



Technical Data		Type 2893AK1
Analog Inputs for any voltage signals	channels	8
Input voltage range	V	-10 ... 10
ADC resolution	Bit	16
ADC sampling rate (per channel)	MHz (MS/s)	1,25
Bandwidth	kHz	100
Low-pass filter	kHz	5/10/20/30
Temperature range	°C	-30 ... 50
Weight	kg	8 (amplifiers included)
Dimensions WxHxD	mm	265,5x212x440

#### Connections

Signal inputs:

8x BNC neg. for analogue voltage input  
2x BNC neg. for connection current clamp

1x Binder neg. for connecting crank angle encoder  
1x Binder neg. for connecting crank angle adapter

Ethernet-Interface

2x D-Sub 9 male CAN-Interface

#### Characteristics

The KiBox is a complete combustion analysis system for mobile use on the road and under extreme ambient conditions.

The KiBox from Kistler enables you to visualize the quality of combustion in the individual cylinders. The combustion parameters are conveniently integrated into the application system and synchronized with other measurement data and the controlled variables of the ECU via a software interface.

This interface is initially available for INCA (the widespread application software from ETAS).

#### Special Advantages of KiBox To Go

- Real time calculation of combustion analysis results
- No optical crank angle encoder required
- Measurements and evaluations can be configured extremely easily. Any error messages displayed are easily understood
- The measurement data is evaluated in the KiBox to avoid any need for your own PC or laptop for combustion analysis. The KiBox can be connected directly to the application PC

#### Application

You can use the additional information about controlling injection valve operation, ignition and combustion for engine maps optimization with the application system. Or you can use the KiBox as a standalone system for combustion analysis in the vehicle. Combustion diagnosis enables you to analyze and solve a problem that arises in the real vehicle on the road.

#### Accessories

##### Charge amplifier

2 channel charge amplifier Type 5064B11  
2 channel PiezoSmart® charge amplifier Type 5064B12

##### Crank angle adapter set

Type 2619A11

##### AC/DC current probe

Type 2103A11

##### PiezoSmart extension cable

Type 1987BN0,5/1987BN7  
Triax neg. – Triax pos.

##### Extension cable

Type 1603BN0,5/1603BN7  
BNC neg. – BNC pos.

Data sheet 2893A\_000-724

## Testers

### Insulation Tester



#### Connection

Input: BNC neg.

Technical data		Type 5493
Measuring range	$\Omega$	$10^{11} \dots 4 \cdot 10^{13}$
Measuring voltage	VDC	5
Max. permissible voltage	V	700
Max. cable length	m	100
Power supply (battery)	VDC	9
Weight	kg	0,3
Dimensions WxHxD	mm	80x172x35

#### Characteristics

Portable unit for measuring insulation resistance. Logarithmic display, extremely easily operated, switches off automatically when not in use.

#### Applications

Equipment whose operation depends on high insulation resistances should be checked periodically or before use. Insulation tester Type 5493 was developed for this purpose. It is designed as a portable service unit using battery power and is suitable for routine field checks on piezoelectric sensors, charge amplifiers and cables.

#### Accessories

None

**Data sheet** 5493\_000-354

### Charge Calibrator



#### Connection

Charge output:

Version 1: Type: BNC neg.

Versions 2 ... 5: Fischer 5 pin

Technical data		Type 5357B...
Charge range (6 ranges)	pC	$\pm 10 \dots 999\,000$
Error (15 ... 35 °C)	%	$< \pm 0,5$
Error (0 ... 50 °C)	%	$< \pm 0,8$
Power supply (switchable)	VAC	230/115 (48 ... 62 Hz)
Weight	kg	$\approx 2$
Dimensions WxHxD	mm	94x151x195

#### Characteristics

Piezoelectric measuring systems can be checked and calibrated with the charge calibrator. The charge calibrator is connected instead of the sensor or in parallel with it in the measuring chain. Up to five charge amplifiers can be connected. The unit is operated with the keypad or via optimal interfaces. The parameters set appear on the LCD.

#### Application

A typical application is the combination of a charge calibrator with 1 ... 5 charge amplifiers. Charge calibration becomes increasingly advantageous as the measuring system becomes more complex. The benefits are twofold: more accurate measurement (determined by the accuracy of the calibrator rather than the sum of the accuracies of all of the devices in the measuring chain), and a check on whether one instrument of the measuring chain has been accidentally misadjusted since it was last tested.

#### Accessories

Connecting cable for 4 additional charge amplifiers Type 1629, Fischer 5 pin pos. – 4 x BNC pos.

**Data sheet** 5357B\_000-335

# Accessories

## Crank Angle Encoder

### Crank Angle Encoder



Technical data		Type 2614B...
Crank angle signal resolution	CA	720x0,5° (up to 3 600x0,1° optional)
Dynamic accuracy at 10 000 1/min signal delay	CA	0,02
Speed range	1/min	0 ... 20 000
Operating temperature range		
Electronics	°C	-20 ... 70
Crank angle encoder	°C	-30 ... 100
Supply		from indication system
Weight (sensor)	g	460
Weight (amplifier)	g	300
Dimensions (amplifier) WxHxD	mm	98x64x37

#### Characteristics

The crank angle encoder Type 2614B... provides the basis for all measurements related to crank angle. This encoder can be used in conjunction with most engine pressure indicators (speed range 0 ... 20 000 1/ min). It is very robust and withstands high mechanical loads.

#### Application

The encoder is used wherever its angular values are required for calculating the IMEP and other combustion characteristics. Suitable for cold start.

#### Accessories

Adapter flange for Type 2613B  
Pulse multiplier Type 2614B4 (optional)

**Data sheet** 2614B\_000-900

## Temperature Conditioning Unit

### Temperature Conditioning Unit



Technical data		Type 2621E...
Coolant reservoir	l	≈6
Flow rate/sensor	l/min	0,25 ... 0,5
Water pressure	bar	1,7 ±0,2
Thermostat regulation range	°C	50 ±3
Heating capacity	W	800
Cooling capacity (at temp. of 35 °C)	W	>2 200
Sensor connections		10
Voltage	VAC	230/115
Power consumption	VA	<1 100
Dimensions WxHxD	mm	200x759x696
Total weight (without coolant)	kg	≈50

#### Characteristics

Temperature conditioning unit with closed circuit for up to 10 water-cooled sensors and adapters. The coolant is stabilized at 50 °C. The special pump circulates the coolant evenly. This ensures stable, precise and reliable measurements even over extended periods of time.

#### Applications

For water-cooled cylinder pressure sensors, outlet pressure sensors, and cooling adapters.

#### Accessories

Hose for cooling water  
Type 1203Csp  
Flow guard Type 2625A...

**Data sheet** 2621E\_000-540

# Accessories

## TDC Sensor System

### TDC Sensor with Integral Amplifier and Power Supply



Technical data		Type 2629B...
TDC sensor	Principle Adapter	capacitance M10x1, M14x1,25
Longitudinal adjustment	mm	≈80
Connection		power connector, 4 pin socket for TDC amplifier and BNC socket for TDC signal output
Dimensions (LxWxH)	mm	125x80x57
Weight	kg	0,5
Amplifier	Principle Sensitivity	capacitance to voltage converter 4
Output		0 ... 10, short circuit proof, switchable to charge output
Max. length of cable for TDC power supply	m	10

#### Characteristics

The TDC system consists of the TDC sensor with integral amplifier and power supply. It is used for dynamic determination of top dead center (TDC) on piston engines. This system consists of:

- TDC sensor
- TDC amplifier
- Power supply
- Power cable

#### Application

The TDC sensor Type 2629B... is used for dynamic determination of TDC of the engine cranked in the unfired mode. It is mounted in the nozzle holder or spark plug bore of the engine.

Accurate determination of TDC is an important basis for precise pressure indication on internal combustion engines.

#### Accessories

Adapters  
Type 6592A1 M10x1,  
Type 6592A2 M14x1,25,  
Type 6592A3 M14x1,25 tapered

Data sheet 2629B\_000-541

### Measuring Torque Flange

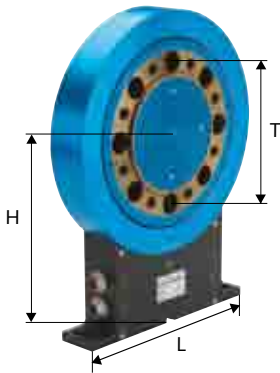

Technical data		Type 4504B...
Rated torque $M_{nom}$	N·m	50/100/200/500/1 000/2 000/3 000/5 000
Overload		
Limiting torque		<2 x rated torque
Alternating torque		<1 x rated torque
Accuracy class	%	0,1
Output signal	V kHz	±0 ... ±10 10 ±5, 60 ±20, 100 ±40 (depending on design) digital with RS-232C
Speed measurement	pulses/rev.	max. 3 600
Nominal speed	1/min.	<15 000
Balancing class	Q	6,3
Operating temperature range	°C	10 ... 60
Housing material		hard anodized aluminum
Dimensions	D (mm) L (mm) H (mm)	105 ... 206 190 167,5 ... 226,5
Connector		Binder, 7,8 and 12 pole

#### Characteristics

Torque measuring flange based on the strain gage principle. Integral digital measurement conditioning system produces analog or digital output signals, which are transmitted without contact. Rotor runs in the stator ring without bearings and is free of wear.

#### Application

The extremely narrow profile makes this measuring flange ideal for test stand applications including engines, gearboxes, rollers, electric motors and pumps.

Data sheet 4504B\_000-805

# Calibrating

## Calibration of Piezoelectric Sensors (Continuous) up to 250 bar

### System Configuration

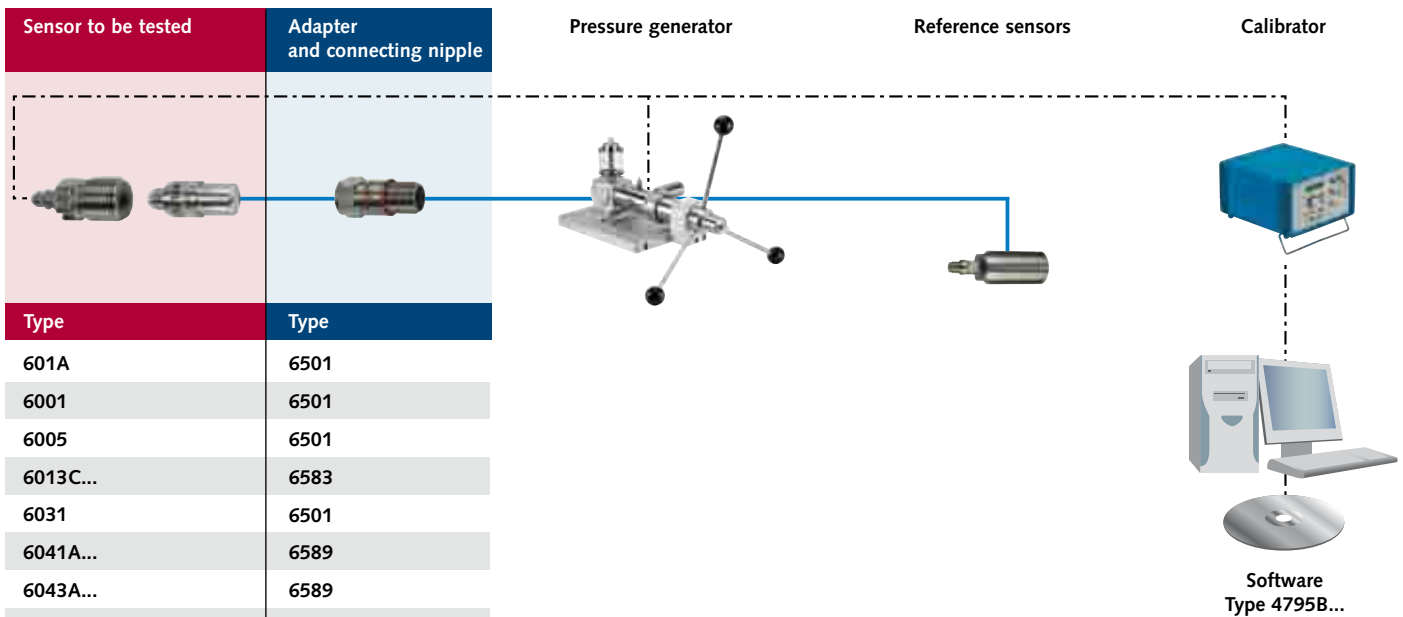

### or Calibration System with Calibrate™ Software

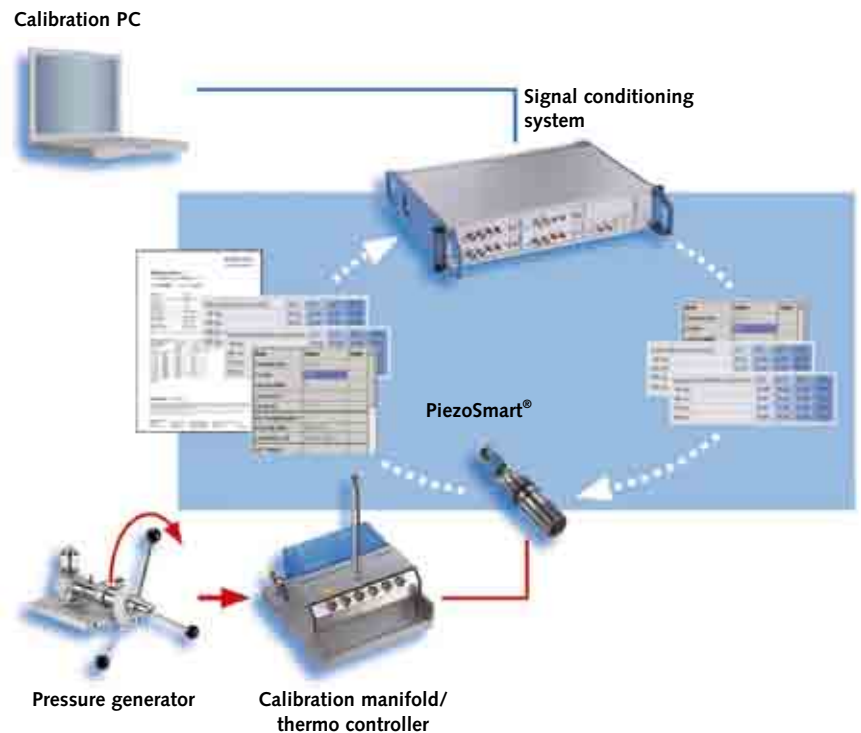



# Calibrating

## Charge Calibrators

### Precision Charge Calibrator



Technical data		Type 5395A...
Voltage (2 ranges)	V	±1, ±10
Error (voltage)	%rdg + %FSO	<± (0,015 + 0,005)
Charge range (6 ranges)	pC	±100 ... 2 000 000
Error (charge)	%rdg + %FSO	<± (0,04 + 0,005)
Input voltage range (monitor)	V	0 ... ±11,5
Interface		IEEE-488
Power supply (switchable)	VAC	230/115 (48 ... 62 Hz)
Weight	kg	4
Dimensions WxHxD	mm	236x151x255

#### Connection

Voltage output: BNC neg.  
 Charge output: BNC neg.  
 Monitor input: BNC neg.  
 Monitor output: BNC neg.

#### Characteristics

The calibrator contains an adjustable precision voltage source reference capacitors and a monitor for measuring the output voltage of the sensor under test. It offers the choice of continuous signals or charge pulses. The optimized duty factor of the charge pulses reduces the unavoidable errors (dielectric relaxation, drift) to a minimum.

#### Application

The precision charge calibrator Type 5395A... is used for calibrating charge amplifiers.

#### Accessories

PC software Type 2835A1-3 for calibrating charge amplifiers and monitors with the precision charge calibrator Type 5395A...  
 Coaxial cable BNC-2 Type 1700A57 for connecting Type 5857 (>V3.3) or Type 5859 to Type 5395A...  
 Adapter Type 1700A58 for sensor input of Type 5852 (from >V3.3) or Type 5859 with Type 5395A...

Data sheet 5395A\_000-337

## Calibration System

### 6 Channel Calibration Manifold



Technical data		Type 6935A...	Type 6935A0
Number of sensors		6	6
Pressure range	bar	0 ... 250	0 ... 250
Calibration method		continuous	continuous
Temperature range	°C	20 ... 250	room temperature
Power supply	VAC	230/115	–
Weight	kg	12	8
Dimensions WxHxD	mm	280x350x330	280x350x180

#### Connection

Sensor connection: M14x1,25

#### Characteristics

Several calibration ports allows the simultaneous calibration of up to six pressure sensors. The calibration block can be heated with high-output electrical elements and in combination with a minimal dead volume, accurate temperature regulation allows quick and effective calibration of several high-temperature sensors.

#### Application

The manifold is particularly suitable for R&D laboratory calibration requirements in engine development. It allows the user to calibrate pressure sensors at typical operating temperatures.

#### Accessories

Calibration fluid Type 1055  
 Blanking plug Type Z18553-20  
 Cu-Be seal Type Z18553-30  
 Torque wrench Type 1300A11

Data sheet 6935A\_000-517

# Calibrating

## Pressure Generators

### Pressure Generator for Continuous and Dynamic Pressure Measurement



#### Connection

Mounting thread: M14x1,25

#### Technical data

Technical data		Type 6904A1
Pressure generation	bar	continuous
Pressure range (continuous)	bar	0 ... 300
Mounting thread	mm	3xM14x1,25
Weight	kg	11
Dimensions WxHxD	mm	280x200x500

#### Characteristics

Continuous pressure generation up to 300 bar.

#### Application

Continuous pressure generation for periodic calibration of quartz and silicon pressure sensors for quality assurance purposes. Comparison measurements for checking the dynamic characteristics of quartz and silicon pressure sensors.

#### Accessories

Reference sensor Type 6961A250, Calibrator Type 6907B...  
Precision charge calibrator Type 5395A...

**Data sheet** 6904\_000-359

### Pressure Generator for High Hydraulic Pressure <10 000 bar



#### Connection

Mounting thread: M10 tapered

#### Technical data

Technical data		Type 6906
Pressure generation	bar	continuous
Pressure range	bar	0 ... 10 000
Mounting thread	mm	2xM10 conus
Weight	kg	15
Dimensions WxHxD	mm	280x250x500

#### Characteristics

Continuous build-up of pressure to 10 000 bar, with swiveling protective hood.

#### Application

Continuous and incremental pressure generation for testing or comparison calibration of high-pressure sensors for quality assurance purposes. The generator also offers the option of maintaining the built-up pressure for up to 5 minutes (e.g. for calibrating a measuring chain).

#### Accessories

Reference sensor Type 7061BK, 6961A250, 6961A500  
Calibrator Type 6907B...  
Precision charge calibrator Type 5395A...

**Data sheet** 6906\_000-360

# Technical Literature

## Special Prints and Application Brochures

### Application to Sensor

Optimization of gas exchange by a suitable combination of pressure indicating, analysis and simulation 920-246

Pressure indicating with measuring spark plugs on a DI-gasoline engine 920-333

Pressure indication during knocking conditions 920-349

Optical indication on combustion engines with smallest sensors 920-350

An improved model for determination of acoustic resonances in indicator passages 920-352

New Opportunities for Gas Exchange Analysis Using Piezoresistive High-Temperature Absolute Pressure Sensors 920-366

### PiezoSmart®

PiezoSmart® – Active system for automatic identification of Pressure Sensors 100-421

### General

Motorenmesstechnik (Buch; Vogel Buchverlag, ISBN 3-8023-1553-7) 900-334

Measuring with crystals (book; Verlag Moderne Industrie, ISBN 3-478-93269-6) 900-335

PiezoStar®-Crystals – A new dimension in sensor technology 920-240



# Glossary

## **Charge amplifier**

A component of a measuring chain, converting the charge signal from the piezoelectric sensor into a proportional voltage signal.

## **Charge Output**

Indicating quantity (in Picocoulomb (pC)) of a piezoelectric sensor, which is not equipped with an integrated charge or voltage amplifier.

## **Coulomb**

Abbreviation is "C". Unit of electric charge. 1 coulomb corresponds to 1 ampere-second (1 C = 1 As).

## **Drift**

Unwanted changes in the output signal independent of the measurand as a function of time.

## **Electrical isolation resistance**

Electrical Resistance of a sensor or cable between the signal lead and the ground lead.

## **Full Scale Output (FSO)**

Range of measurement signal of a sensor, corresponding to the full scale of the measurand. It is the algebraic difference of the upper and lower limit of the measurement signal range.

## **Front sealing**

The sealing part of the sensor is located at the sensor front close to the membrane. This sealing design ensures a good heat transfer from the sensor to its mounting area, which results in a high measuring accuracy and a long lifetime of the sensor.

## **Glow plug adapter**

A glow plug adapter corresponds to the design of a standard glow plug, however, it is not equipped with an electrical connector and a plug for the local heating inside the combustion chamber. A miniaturized piezoelectric pressure sensor is installed in the center of an adapter. The glow plug adapter is mounted in the mounting hole of a glow plug on the cylinder head (diesel engine). It enables measurements of cylinder pressures inside the combustion chamber.

## **Ground insulation**

High electrical resistance of a sensor between signal line and ground, or of a charge amplifier between connector screen and ground.

Note: mass isolation and ground isolation are synonyms.

## **Hysteresis**

The maximum difference in output, at any measurand value within the specified range, when the value is approached first increasing and then decreasing measurand (source: ANSI/ISA-S37.1).

Note: The quartz crystal itself has a scarcely measurable hysteresis. However, the mechanical construction of the sensor can result in slight hysteresis. If the hysteresis is above the specified values (in %FSO), then the sensor is faulty or has not been correctly installed.

## **IMEP**

The Indicated Mean Effective Pressure, usually noted in bar, corresponds to the work of one combustion cycle.

## **Insulation resistance**

Electric resistance of a sensor, cable or the input of a charge amplifier measured between the signal line and the connection ground (sensor body), while the test voltage is stated accordingly. The insulation resistance applies for piezoelectric sensor, strain gauge sensors and semiconductor sensors.

## **Linearity**

Linearity is defined as the closeness of the calibration curve to a specified line (source: ANSI/ISA-S37.1).

Linearity represents the maximum deviation between ideal and actual output signal characteristics in relation to the measurand in a specific measuring range. It is expressed in percentage of the range of measurement signal (full scale output). Note: Quartz crystals produce an electric charge, which is exactly proportional to the load. However, certain unavoidable deviations occur due to the mechanical construction of the sensor.

## **Measuring chain**

Interconnection of several individual components to meet measuring requirements. Measuring chains usually consist of sensors and amplifiers in conjunction with data acquisition, display, evaluation and recording equipment (e.g. PC, printer).

## **Measuring glow plug**

A measuring glow plug forms a special design of a glow plug used for combustion engines (Diesel engine). It is equipped with a piezoelectric pressure sensor. The combination of a glow plug and a piezoelectric sensor allows for the direct mounting in the default mounting hole on the cylinder head of a combustion engine. In particular, the measuring glow plug is supposed for investigations on cold starting tests of diesel engines.

## **Measuring range**

Range of measurand in which the quality of the measurement within the stated tolerances is guaranteed. This range must be regarded as a binding maximum range.

## **Measuring spark plug**

A measuring spark plug corresponds to the design of a spark plug for combustion engines (gasoline engine), however, it is equipped with a piezoelectric pressure sensor. It exhibits the basic function of cyclic spark generation in the combustion chamber and features the dimensions of a standard spark plug. It is mounted on the default mounting hole of the spark plug on the cylinder head of a combustion engine and is supposed for pressure measurements in the combustion chamber.

## **Natural frequency**

Frequency of free (not forced) oscillations of the entire sensor. In practice the (usually lower) natural frequency of the entire mounting structure governs the frequency behaviour.

**Operating temperature range**

Range of ambient temperatures in which the sensor is to be operated. The temperature-dependent tolerances stated apply only within this range.

**Overload**

Maximum value of the measurand with which a sensor can be loaded without sustaining damage. This refers to a safety margin and is not an extended measuring range. The characteristics specified in the calibration certificate are no longer guaranteed in the event of an overload. Nevertheless, measurements made during an overload in most cases provide useful results.

**pC (pico Coulomb)**

1 pico Coulomb =  $10^{-12}$  Coulomb.

See "Coulomb"

**Piezoelectric sensor**

Sensor equipped with a piezoelectric measuring element which provides an electrical charge while mechanical load acts on it.

**Piezoresistive sensor**

Sensor equipped with doped silicon resistors as measuring element which indicates a change in resistance corresponding to the mechanical load acting on it.

**PiezoSmart®**

An active sensor identification system which is based on the IEEE 1451.4 standard and is used for automatically setting measuring chain parameters. The main element of PiezoSmart is an electronic data sheet called TEDS (Transducer Electronic Data Sheet) which contains all the data essential for the configuration of the measuring chain.

**PiezoStar®**

Crystals developed and grown by Kistler for use in sensors for demanding applications.

**Sensitivity**

Nominal value or calibrated value stated in the calibration certificate of the change in the response of a sensor divided by the corresponding change in the value of the measurand.

Note: sensitivity of piezoresistive and strain gauge sensors is additionally dependent on the excitation current or voltage.

**Shoulder sealing**

The pressure sealing surface between the sensor and the test structure is located behind the primary sensing diaphragm towards the cable or connector end of the device. This allows for flush mounting of the sensor with the cylinder wall and therefore reduces the possibility of pipe oscillations.

**Synthetic crystals**

A term used to describe crystal which has been produced by a technological process, as opposed to natural crystal which is produced by a geological process. During this technological process certain characteristics may be determined by alterations in the crystal compounds or the process itself. At Kistler, synthetic crystals are called PiezoStar.

**Thermal shock**

A short-term measuring error that arises periodically within each combustion cycle. It is caused by thermal stresses in the sensor diaphragm, induced by the heat flux of the hot combustion gases which can reach temperatures of over 2 000 °C for a few milliseconds.

**Tribo electricity**

Static electricity generated when electrical charges are released within an electrical cable usually when being moved or bent.





**Cylinder pressure uncooled**  
(from page 24 onwards)

Type 6052C...  
Type 6053CC...  
Type 6054AR...  
Type 6055C...  
Type 6056A...  
Type 6058A...  
Type 6045A...  
Type 6081A...  
Type 6125C...

**Cylinder pressure cooled**  
(from page 30 onwards)

Type 6041B...  
Type 6043A...  
Type 6061B...  
Type 6067C...  
Type 7061B...

**Cooling adapters exhaust**  
(from page 38 onwards)

Type 7533A... – switching adapter  
Type 4045A... to 4075A... – sensors

**Fuel pressure**

(from page 40 onwards)

Type 4065A...  
Type 4067A...  
Type 6229A...

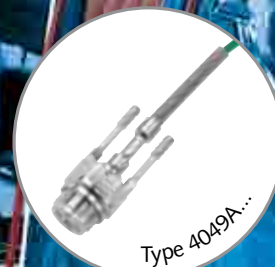
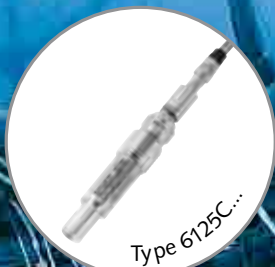

**Cooling adapters exhaust**  
(page 38)  
Type 4049A...



**Accessories**  
(from page 56 onwards)

Type 2614B... – crank angle encoder  
Type 2621E... – cooling unit  
Type 2629B... – TDC sensor system  
Type 4504A... – torque measuring flange

**Inlet**  
(from page 36 onwards)

Type 4005BA...  
Type 4007BA...

**Measuring spark plugs**  
(page 34)

Type 6113B...  
Type 6115B...  
Type 6117B...  
Type 6118B...

**Glow plug adapter**  
(page 27)

Type 6542Q...  
Type 6544Q...



# Product Overview by Type Numbers

Type	Page	Type	Page	Type	Page
1300A9	33	4065A...	40	6061B...	30
1300A17	33	4067A...	40	6067C...	32
1300A51	33	4067C3000...	40	6081A...	28
1300A79	33	4073A...	38	6113B...	34
1319	33	4075A...	38	6115B...	34
1357A	33	4155	23	6117B...	34
1603B...	45	4260A...	42	6118B...	34
1631C...	45	4262A...	42	6125C...	28
1635C...	45	4264A...	42	6229A...	40
1637C5	45	4504A...	57	6442	21
1651C...	45	4603B...	52	6444	21
1655C...	45	4618A...	53	6445	21
1673A...	43	4665	49	6447	23
1700A...	44	4751A...	45	6449	23
1704A...	44	4753A...	45	6469	21
1705	21	4757A...	45	6472A...	20
1706	21	4761B...	45	6473A...	20
1721	21	4763B...	45	6474A...	20
1919A...	45	4765A...	45	6475	21
1921	45	4767A...	45	6477	21
1927A...	21	5018A...	52	6503	23
1929A...	45	5064B...	48	6525A...	21
1957A...	45	5227...	51	6533A...	41
1967A...	45	5247	51	6542Q...	21
1969A...	45	5269	49	6544Q...	21
1975A...	45	5271	50	6596	22
1983A...	44	5357B...	55	6598	22
1985A...	43	5395A...	59	6904A1	60
1989A...	45	5493	55	6906	60
2614A...	56	5613...	50	6919	23
2621E...	56	5700	47	6925	23
2629B...	57	6041B...	30	6935A...	59
2852A...	48	6043A...	30	7061B...	32
2853A...	47	6045A...	28	7441	21
2854A...	47	6052C...	24	7501	22
2893AK1	54	6053CC...	24	7503	22
4005B...	36	6054AR...	24	7505	23
4007B...	36	6055C...	24	7507	23
4043A...	38	6056A...	26	7511	23
4045A...	38	6058A...	26	7525	22
4049A...	38			7533A...	39

PiezoSmart®, PiezoStar®, Piezotron®, Polystable® and ThermoComp® are registered trademarks of Kistler Holding AG.

Microsoft® is a registered trademark of Microsoft Corporation.

Teflon® and Kapton® are registered trademarks of DuPont.

Viton® is a registered trademark of DuPont Performance Elastomers.

# Kistler Worldwide

## Europe

### Austria

Kistler GmbH  
Lemböckgasse 49f  
1230 Wien  
Tel. +43 1 867 48 67 0  
sales.at@kistler.com

### Czech Republic/Slovakia

Kistler, s.r.o.  
Zelený pruh 99/1560  
140 00 Praha 4  
Tel. +420 296 374 878  
sales.cz@kistler.com

### Denmark

Kistler Nordic DK  
Grønlandsvej 4  
4681 Herfølge  
Tel. +45 70 20 85 66  
info.dk@kistler.com

### Finland

Kistler Nordic AB  
Särkiniementie 3  
00210 Helsinki  
Tel. +358 9 612 15 66  
info.fi@kistler.com

### France

Kistler France  
ZA de Courtabœuf 1  
15, avenue du Hoggar  
91953 Les Ulis cedex  
Tel. +33 1 69 18 81 81  
info.fr@kistler.com

### Germany

Kistler Instrumente GmbH  
Daimlerstrasse 6  
73760 Ostfildern  
Tel. +49 711 34 07 0  
info.de@kistler.com

### Italy

Kistler Italia s.r.l.  
Via Ruggero di Lauria, 12/B  
20149 Milano  
Tel. +39 02 481 27 51  
sales.it@kistler.com

### Netherlands

Kistler B.V. Nederland  
Leeghwaterstraat 25  
2811 DT Reeuwijk  
Tel. +31 182 304 444  
sales.nl@kistler.com

### Spain

Kistler Ibérica S.L., Unipersonal  
C/Pallars, 6 Planta 2  
08402 Granollers  
Barcelona  
Tel. +34 93 860 33 24  
info.es@kistler.com

### Sweden/Norway

Kistler Nordic AB  
Aminogatan 34  
431 53 Mölndal  
Tel. +46 31 871 566  
info.se@kistler.com

### Switzerland/Liechtenstein

Kistler Instrumente AG  
Eulachstrasse 22  
8408 Winterthur  
Tel. +41 52 224 12 32  
sales.ch@kistler.com

### United Kingdom

Kistler Instruments Ltd.  
13 Murrell Green Business Park  
Hook, Hampshire RG27 9GR  
Tel. +44 1256 74 15 50  
sales.uk@kistler.com

## Asia

### China, People's Republic of

Kistler China Ltd.  
Unit D, 24/F Seabright Plaza  
9-23 Shell Street North Point  
Hong Kong  
Tel. +852 25 915 930  
sales.cn@kistler.com

### India

Kistler Instruments (India) Pvt .Ltd.  
TA-3,3<sup>rd</sup> floor, Crown Plaza,  
Sector-15 A, Faridabad - 121 007  
Haryana/India  
Tel. +91 129 4113 555  
sales.in@kistler.com

### Japan

Kistler Japan Co., Ltd.  
23<sup>rd</sup> floor, New Pier Takeshiba North Tower  
1-11-1, Kaigan, Minato-ku  
Tokyo 105-0022  
Tel. +81 3 3578 0271  
sales.jp@kistler.com

### Korea, Republic of

Kistler Korea Co., Ltd.  
Gyeonggi Venture Anyang  
Technical College Center 801  
572-5, Anyang-Dong, Manan-Gu,  
Anyang-City, Gyeonggi-Do 430-731  
Tel. +82 31 465 6013  
sales.kr@kistler.com

### Singapore

Kistler Instruments (Pte) Ltd.  
50 Bukit Batok Street 23  
#04-06 Midview Building  
Singapore 659578  
Tel. +65 6316 7331  
sales.sg@kistler.com

### Taiwan

Kistler Branch Office in Taiwan  
5F-17, No. 6, Lane 180  
Sec. 6, Mincyuan E. Road  
Taipei 114  
Tel. +886 2 7721 2121  
sales.tw@kistler.com

### Thailand

Kistler Instrument (Thailand) Co., Ltd.  
26/56 TPI Tower, 20th Floor  
Nanglingee Rd., (Chan Tat Mai Rd.)  
Thungmahamek, Sathorn  
Bangkok 10120  
Tel. +66 2678 6779-80  
sales.thai@kistler.com

## America

### USA/Canada/Mexico

Kistler Instrument Corp.  
75 John Glenn Drive  
Amherst, NY 14228-2171  
Tel. +1 716 691 5100  
sales.us@kistler.com

## Australia

### Australia

Kistler Instruments Australia Pty Ltd  
Unit 1.23/202 Jells Rd.  
Wheeler's Hill, Victoria 3150  
Tel. +61 3 9560 5055  
sales.au@kistler.com

## Other Countries

Kistler Instrumente AG  
Export Sales  
Eulachstrasse 22, 8408 Winterthur  
Switzerland  
Tel. +41 52 224 11 11  
sales.export@kistler.com

[www.kistler.com](http://www.kistler.com)

**KISTLER**  
measure. analyze. innovate.

## Headquarters

### Switzerland

Kistler Group  
Eulachstrasse 22, 8408 Winterthur  
Tel. +41 52 224 11 11  
Fax +41 52 224 14 14  
info@kistler.com