



آزما صنعت گراد



نماینده انحصاری کمپانی **Mahr** آلمان

|
- 0 +



EXACTLY

MARSURF | MARSURF UD 120 / MARSURF LD 120

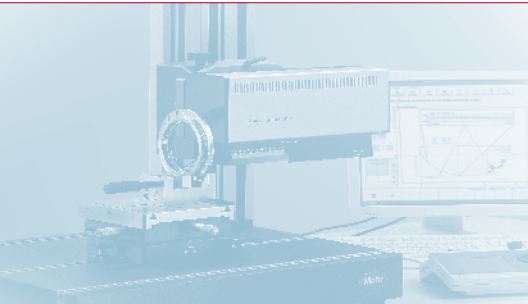

COMBINED CONTOUR AND ROUGHNESS MEASUREMENTS

|
- 0 +

Mahr

E X A C T L Y

MarSurf UD 120 / LD 120. Two in One

THE UNIVERSAL CONTOUR AND SURFACE MEASURING SYSTEM AS A COMPACT MEASURING STATION

▶ | Combined contour and roughness measurements can be excellently solved in one measuring run with the leading Mahr technology and metrology. The MarSurf UD 120 and MarSurf LD 120 enable high-precision measurements in the nm range. Patented solutions, such as the probe arm changer, distinguish these measuring stations for automatic measuring operation.

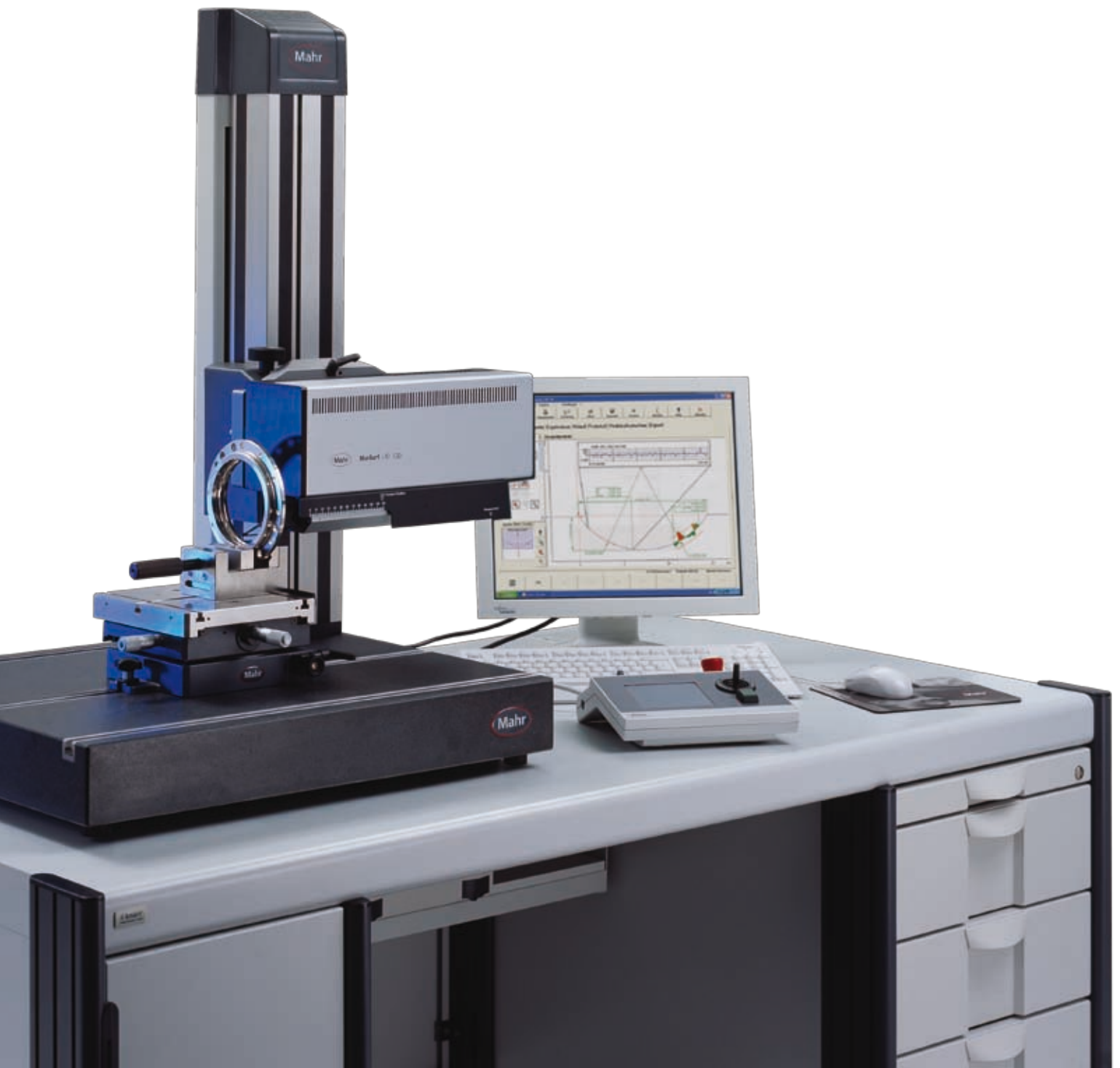

MarSurf UD 120 / LD 120

Combined contour and roughness measurements



Description

MarSurf UD 120

The MarSurf UD 120 is the universal basic unit for combined contour and roughness measurements in one measuring run. The MarSurf UD 120 enables resolutions in the nm range.

MarSurf LD 120

The MarSurf LD 120 has been well-established on the market for years already and represents the leading technology for contour and roughness measurements.

Residual values of $R_z=35$ nm or the dynamic measuring force control between 0.5 and 30 mN, guarantee highest precision.

In combination with a universal measuring, control and evaluation software by Mahr, MarSurf UD 120 / LD 120 provides you with a leading technology measuring station for contour and roughness. MarSurf UD 120 / LD 120 is delivered with the XCR 20 CNC software package, which is built upon the so-called MarWin platform. This modular software provides you with an extensive measuring and evaluation comfort for contour and roughness. The drive unit axes as well as the measuring stand axis e.g., can be controlled both with the joystick or by the software program.

• Roughness and contour in one measuring run

You need only a fraction of the time and your work is faster, more reliable and more efficient. After just one measurement, you have all the roughness and contour results characteristics at a glance.

This leaves you more time for other tasks!

• The most modern converter technology for small tolerances

allows for high accuracy over a large measuring range with high resolution. You can manage measuring tasks with narrow tolerances and therefore take on new challenges.

• Innovative tracing arm concept for maximum stability

The tracing arms, which have been designed using bridge-building techniques, ensure **maximum rigidity, low-oscillation measurements and unwavering precision**. They are your bridges - to new dimensions of flexibility!

• Probe arms with magnetic holder

The magnetic holders ensure a high degree of system and collision protection as well as longevity.

MarSurf UD 120 / LD 120 - MarWin

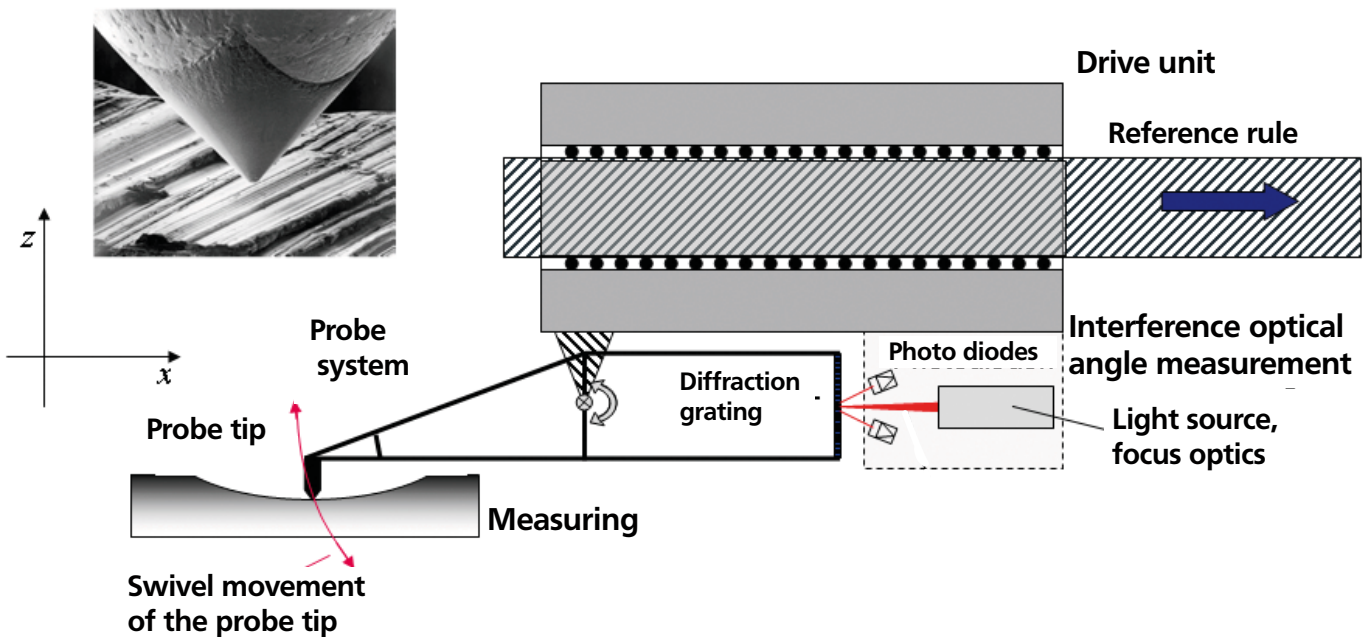

System description

Measuring station components
Drive unit MarSurf UD 120 /LD 120

MarSurf UD 120 / LD 120 drive units facilitate traversing lengths from 0.1 mm up to 120 mm with tracing speeds between 0.1 mm/s and 2 mm/s. Due to a glass scale in x-direction, automatic positioning is possible.

Tracing system
Operating principle

The tracing principle is based on a rocker system with a stylus tip on one and a diffraction grid on the other side of the rotary axis. The light of a diode is focused on the diffraction grid bringing out an interference pattern. Moving up and down the diffraction grid leads to changes in the interference on the receptor side which is registered by photo diodes. From this, an electronic evaluation circuit determines the position of the grid and consequently of the stylus tip.

A moving coil motor is used for probe positioning in z - direction and tip force control.

The probe arms LD A14-10-2 90°, LD A14-10-500 (LD 120), LD A14-10-2 60° (UD 120) for the most frequent applications are included in the scope of delivery. The frame-work constructions of the tracing arms ensure a high degree of stiffness and leads to high precision and reliability.

For different measuring tasks, various tracing arm and stylus tip geometries are available. According to the measuring task, you can use diamond tips with 2 µm radius for roughness measurements, carbide tips with 25 µm radius for contour measurements as well as ruby balls. By means of an adequate selection of the stylus tip, short-wave and long-wave profile components can be recorded and evaluated in one measuring run.

MarSurf UD 120 / LD 120 MarWin

Measuring with UD 120 / LD 120

The simple, quick and more dependable way
From testpiece to measurement and final result:



Processing machines

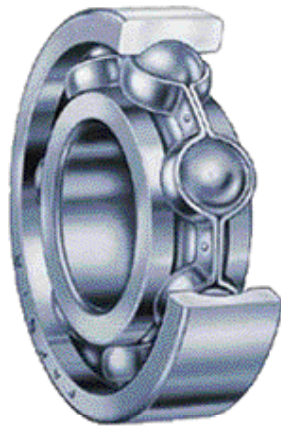

Testpiece

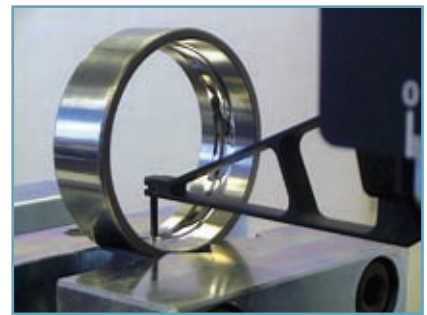

Measurement

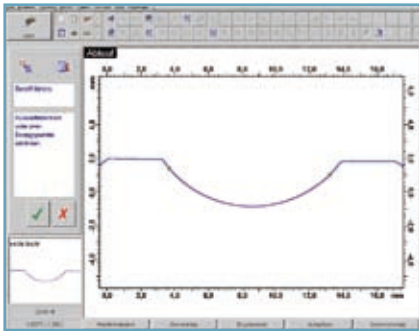

Result

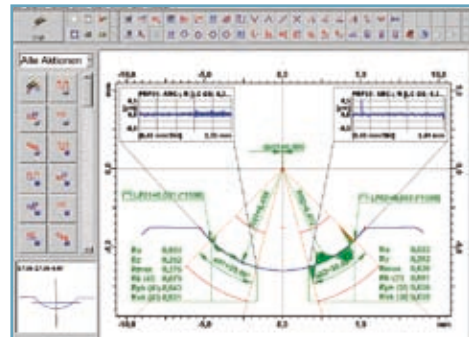

MarSurf UD 120

Combined contour and roughness measurements

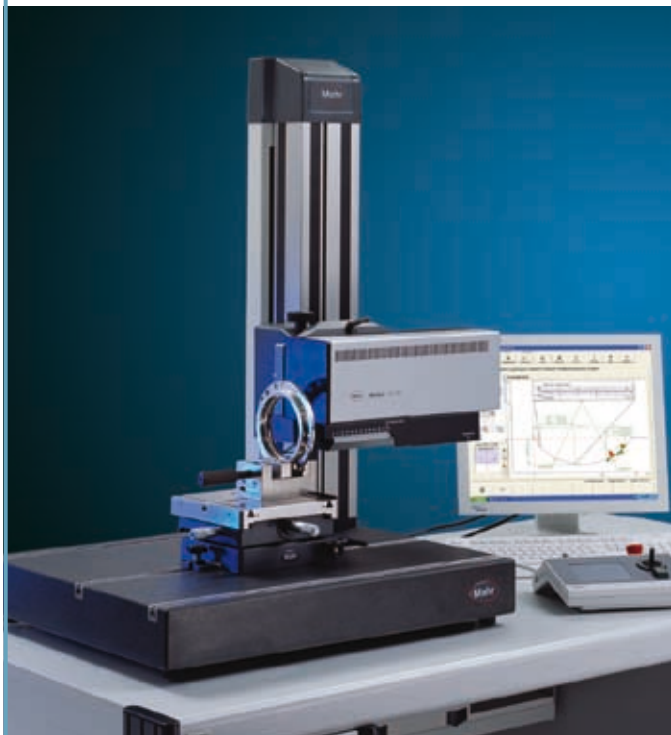

Scope of delivery MarSurf UD 120 Measuring Station

Order no.	6910046
PC	6268382
including MidRange control and MarSurf XCR 20 software	
Country package WIN XP	62682xx
Monitor 19" TFT	5460043
Drive unit MarSurf UD 120	6720817
incl. tracing arm LD A 14-10-2/60°	6852005
Manual control panel MCP 21	7033935
Measuring stand ST 500 CNC	6710254
with Hz adjustment and granite plate	
including control module	6851376
UD 120 / LD 120 adaptor	6851360
for measuring stand ST 500 CNC	
Safety package UD 120 / LD 120	7033457
Calibration standard	6820121
X/Y table CT 200	6710530
Damping elements	6851368

Technical Data

Measuring system	optic
Traversing length	0.1 mm to 120 mm
Pick-up measuring range	10 mm to 20 mm (with double probe arm length)
Standard stylus tip	LD A14-10-2/60°, diamond 2 µm, 60° (6852005)
Resolution in z	2 nm
Horizontal measuring axis	glass scale
Measuring point distance in X	0.25 µm to 1 µm
Residual value Rz0	60 nm
Measuring force	1 mN to 30 mN adjustable via software
Measuring speed	0.1 mm/s to 2.0 mm/s in 0.1mm increments for contour measurements ≤ 0.5 mm/s for roughness measurements
Return speed and Positioning speed in X	up to 4 mm/s
Contacting deviation	0.2 µm
Display deviation for distance measurement MPE _{EA}	± (1 + 2L/150) µm
Example: Distance 50 mm	± 1.66 µm
Angle measurement	1.5 minutes
Radius deviation MPE _R	
R ≤ 10 mm	± 1.5 µm
10 mm < R ≤ 100 mm	± (3R/20) µm
R > 100 mm	± (-7.5 + 9R/40) µm
Example: R 10 mm	± 1.5 µm
General Data	
Operating temperature	15 °C to 30 °C
Recommended working temperature	20 °C ± 2 K
Storage temperature/transport temperature	0 °C to 40 °C (in transport packaging)
Relative humidity	30 % to 80 %

MarSurf UD 120. Accessories

Easy and precise probe arm change on the MarSurf UD 120 / LD 120

The probe arms included in the standard scope of delivery enable the measurement of contour and roughness at the most various of measuring points for many workpieces. It is not always possible, however, to fulfill all measuring tasks with just one probe arm. A different one may be required for e.g. measurements in very small bores or in deep recesses or measurements with the twin probes.

In these cases, changing the probe arm is very simple for the operator. Without additional tools, the magnetically held probe arm can easily be removed by hand. The other probe arm can be inserted within seconds. A ball stop assures that the position fits to the μm .

Calibration of the different probe arms takes place only once, the calibration data is saved - that means that a new calibration is not necessary after changing probe arms!

An essential advantage in regards to operation and time with MarSurf UD 120 / LD 120!



MarSurf UD 120/LD 120 Probe Arm LD A14-10-2/60° Order no. 6852005

Entire length up to pivot point:	100 mm
Length up to probe arm mount:	73 mm
Can be used for:	
Bores \varnothing 14 mm up to meas. depths of	7 mm
Probe pin length below the probe arm:	10 mm
Measuring range:	10 mm
Stylus tip radius / material:	2 μm / diamond
Opening angle of the stylus tip:	60°
Probe pin (or probe insert):	Titan (exchangeable)
Basic probe arm LD-A:	Aluminum

MarSurf LD 120 Standard Probe Arms

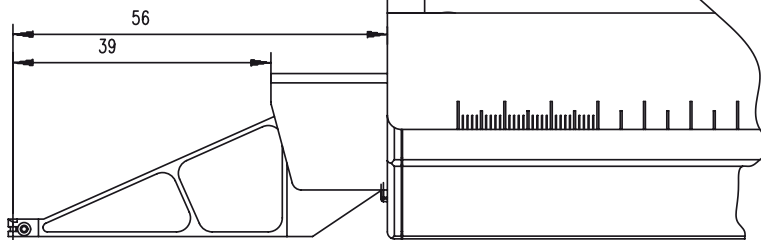

<p>LD A-10 Grund-Tastarm Basic tracing arm 0T5005-0200.000 6852001</p> <p>Drehpunkt Pivotal point</p>	<p>LD A14-10-2 Tastarm Tracing arm 0T5005-0211.000 6852002</p> <p>Diamond stylus tip R=2μm/90°</p>	<p>LD A14-10-2/60° Tastarm Tracing arm 0T5005-0214.000 6852005</p> <p>Diamond stylus tip R=2μm/60°</p>	<p>LD A14-10-500 Tastarm Tracing arm 0T5005-0212.000 6852003</p> <p>Rubin ball R=500 μm</p>
---	--	--	---

MarSurf LD 120

Combined contour and roughness measurements

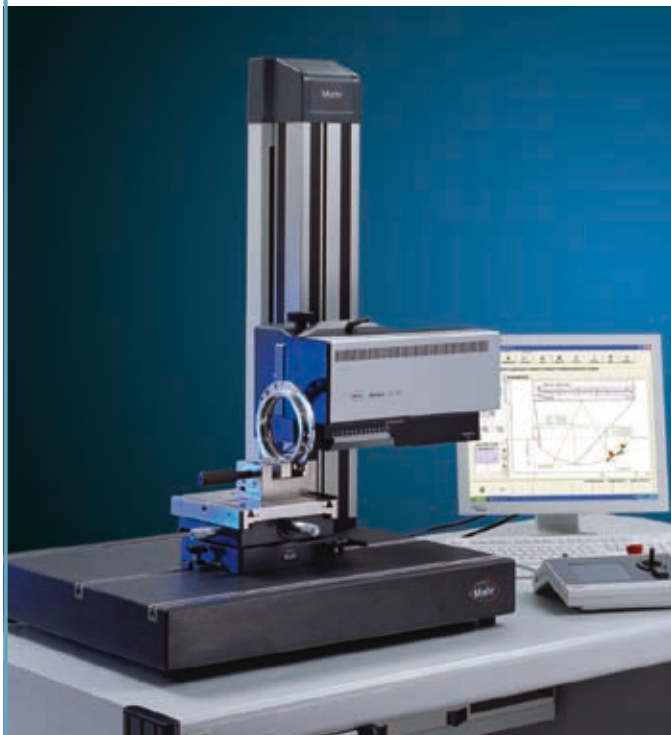

Scope of delivery MarSurf UD 120 Measuring Station

Order no.	6910046
PC	6268382
including MidRange control and MarSurf XCR 20 software	
Country package WIN XP	62682xx
Monitor 19" TFT	5460043
Drive unit MarSurf LD 120	6720814
incl. 2 probe arms	
Manual control panel MCP 21	7033935
Measuring stand ST 500 CNC with Hz adjustment and granite plate	6710254
including control module	6851376
UD 120 / LD 120 mount	6851360
for measuring stand ST 500 CNC	
Safety package UD 120 / LD 120	7033457
Calibration standard	6820121
X/Y table CT 200	6710530
Damping elements	6851368

Technical Data

Measuring system	optical
Traversing length	0.1 mm to 120 mm
Probe measuring range	10 mm to 20 mm (with double probe arm length)
Standard probe arms	LD A14-10-2, diamond tip 2 µm, 90° (6852002) LD A14-10-500, ruby ball 500 µm (6852003)
Resolution in Z	2 nm
Horizontal measuring axis	glass scale
Measuring point distance in x	0.05 µm to 1 µm
Residual value Rz0	35 nm
Measuring force	0.5 mN to 30 mN adjustable via software
Measuring speed	0.5 mm/s to 2.0 mm/s in 0.1 mm increments for contour measurements ≤ 0.5 mm/s for roughness measurements
Return speed and Positioning speed in X	up to 4 mm/s
Contacting deviation	0.1 µm
Display deviation for distance measurement MPE _{EA} Example: Distance 50 mm	± (1 +L/100) µm ± 1.5 µm
Angle measurement	0.5 min
Radius deviation MPE _R R ≤ 10 mm	± 1 µm
10 mm < R ≤ 300 mm	± (R/10) µm
R > 300 mm	± (30 + R/5) µm
Example: R 10 mm	± 1.0 µm
General Data	
Operating temperature	15 °C to 30 °C
Recommended working temperature	20 °C ± 2 K
Storage temperature/transport temperature	0 °C to 40 °C (in transport packaging)
Relative humidity	30 % to 80 %

MarSurf LD 120. Accessories

Highest accuracy with MarSurf LD 120

The afore stated technical data of the LD 120 shows extraordinary values, such as the residual value Rz0 of 35 nm or the resolution of 2 nm and a settable measuring force from 0.5 mN to 30 mN.

The measuring point distance of 0.05 μm enables the exact measurement of micro contours and edge chamfers.

For you as a customer, a successful acceptance procedure and the ability of the units to perform your measuring task play the decisive role. MarSurf LD 120 has been tested and well-proven by several hundred customers world-wide.

The clever mix of intelligent solutions in the fields of mechanics, electronics, optics, control technology and software engineering guarantee the high accuracies so that you can reliably measure dimensions with tolerances in the μm range.

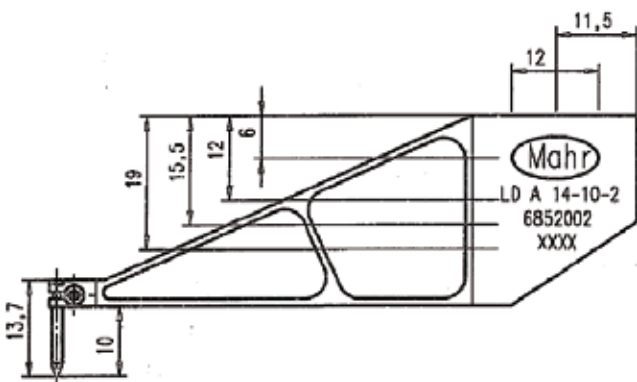

Probe Arm LD A14-10-2

Probe arm LD A14-10-2/90°

Order no.
6852002

Complete length up to pivot point :
Length up to probe arm mount:

100 mm
73 mm

Can be used for:

Bores \varnothing 14 mm up to measuring depths of	7 mm
Probe pin length below the probe arm:	10 mm
Measuring range:	10 mm
Stylus tip radius / material:	2 μm / diamond
Opening angle of stylus tip:	90°

Probe pin (or probe insert):
Basic probe arm LD-A:

Titan (exchangeable)
Aluminum

The probe arm belongs to the basic scope of delivery of the LD 120 drive units.

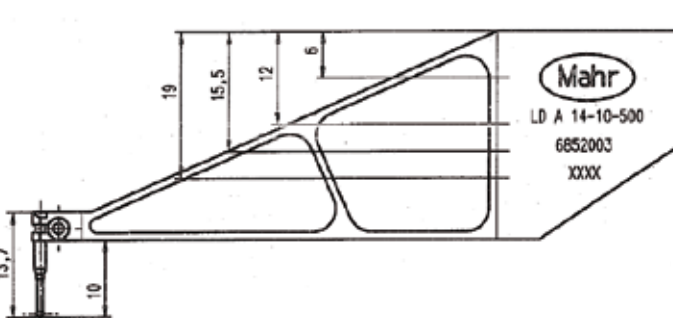

Probe Arm LD A14-10-500

Probe arm LD A 14-10-500

Order no.
6852003

Complete length up to pivot point :
Length up to probe arm mount:

100 mm
73 mm

Can be used for:

Bores \varnothing 14 mm up to measuring depths of	7 mm
Probe pin length below the probe arm:	10 mm
Measuring range:	10 mm
Stylus tip radius / material:	500 μm / ruby
Opening angle of stylus element	Ball

Probe pin (or probe insert):
Basic probe arm LD-A:

Titan (exchangeable)
Aluminum

MarWin Software for MarSurf XC 2 / XC 20

MarWin-based software – user benefits

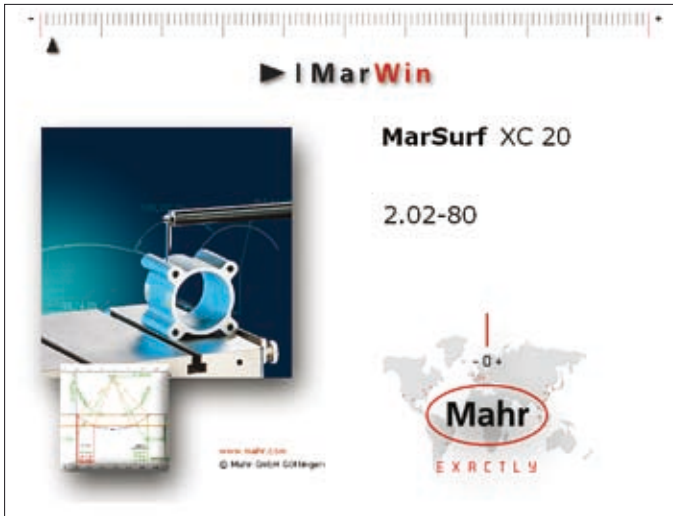

Description

The user-friendly **MarWin** software platform features many different measuring and evaluation criteria. Standardized icons, identical operating sequences in any of the applications and clear-cut assignment of user rights are just a few of the many features making life easier for users.

It is possible to add further **MarWin**-based software applications such as **XR 20** or **XT 20** at any time. The simplified measuring station display showing the measuring setup's axes makes work quick and easy.

The travel speed of the **ST 500 / ST 750** measuring stand and of the additional axes can be selected directly in 3 steps. To facilitate zenith searches, the display area can be set to the optimal zoom.

Operation is made much easier thanks to easily recognizable icons. As many users configure measuring runs in line with their own priorities, icons can be selected as **Preferences**. The Help function for the selected icon can be activated at any time.

Setting the measurement conditions, positioning the probe in the "loading station" and in the measuring position, as well as after measurement and entering the parameters with all boundary conditions are all possible in "Measuring assistant" view.

Multiple measurements, operator prompts during a measurement procedure, and many other features are supported in clear and easy operating steps.

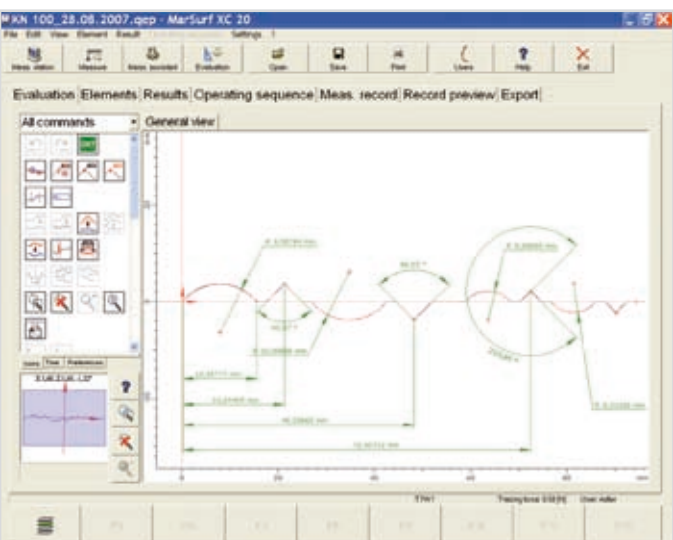
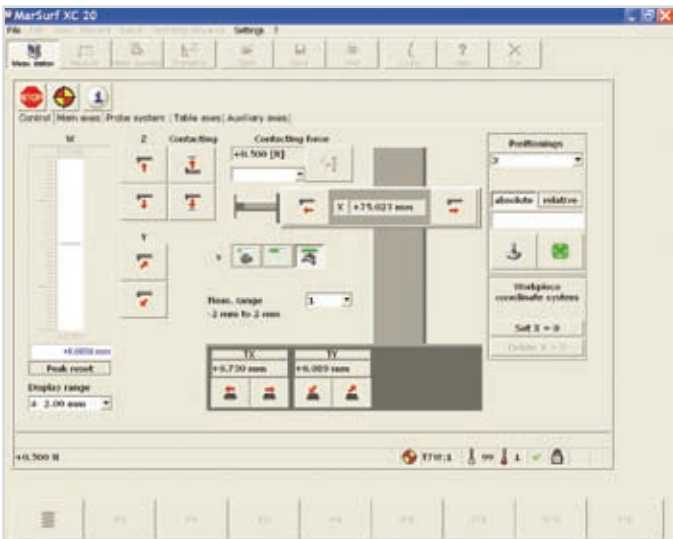

MarWin Software for MarSurf XC 2 / XC 20

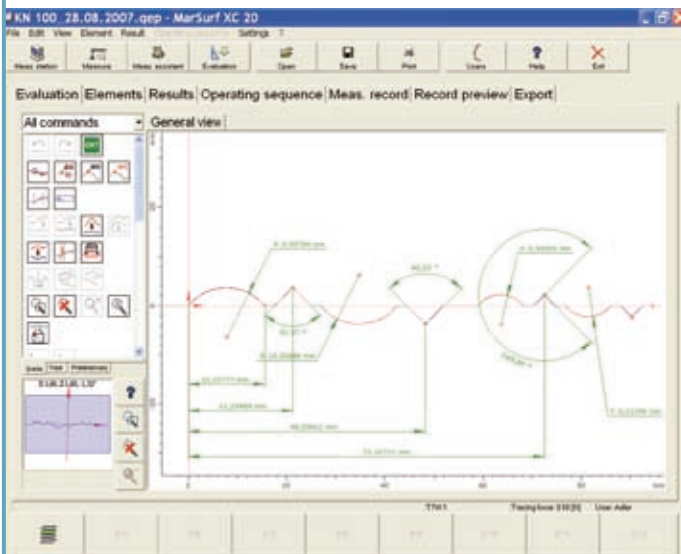

Standard evaluation

Fast and straightforward evaluation of basic geometric elements such as radii, angles, and distances to coordinate axes is made possible without the slightest effort by means of tools from the action box.

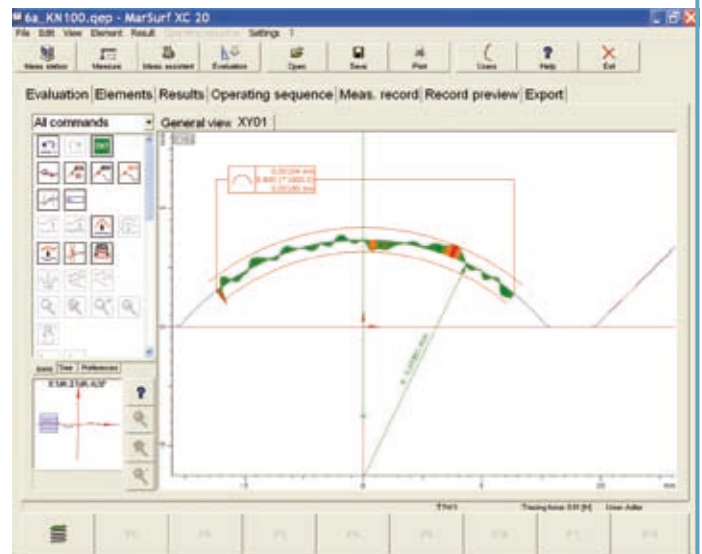

Line form evaluation

Deviations of the actual geometry from the nominal geometry are shown graphically. The selected tolerance band shows at a glance whether the work-piece is inside or outside the tolerance.

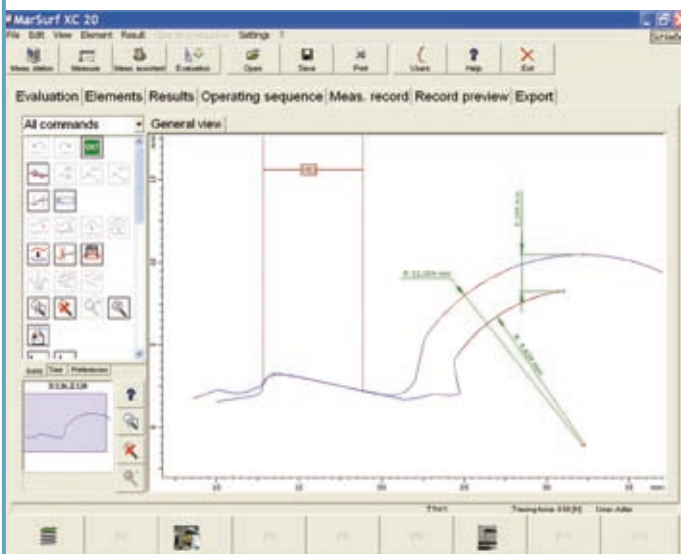

Nominal/actual comparison

Comparing an actual profile to a nominal profile is one of the most demanding tasks in contour evaluation. In the example shown above, adaptation is performed in the profile section displayed. Differences in dimensions can now be calculated that in this case reflect the wear and tear of a tool.

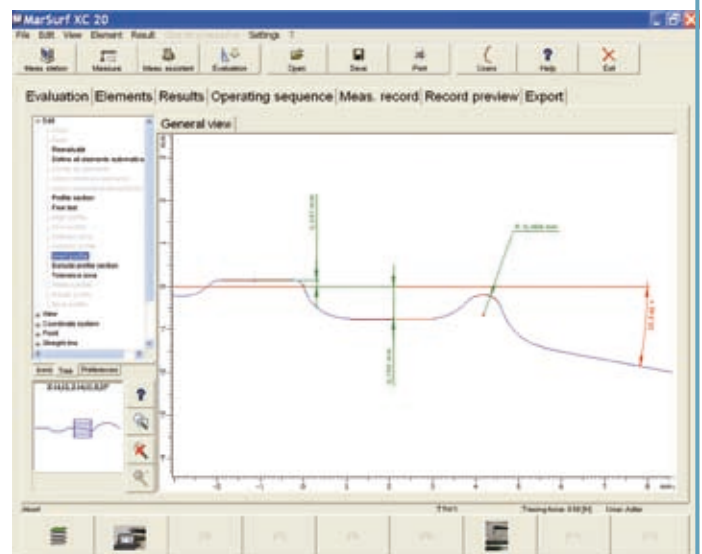

Creation of auxiliary datum elements

Many technical drawings of workpieces contain dimensions that are not referenced solely to the visible edges but also to auxiliary datum elements. The creation of a parallel to a workpiece edge is shown in the above example.

Measurement Using a Twin Stylus

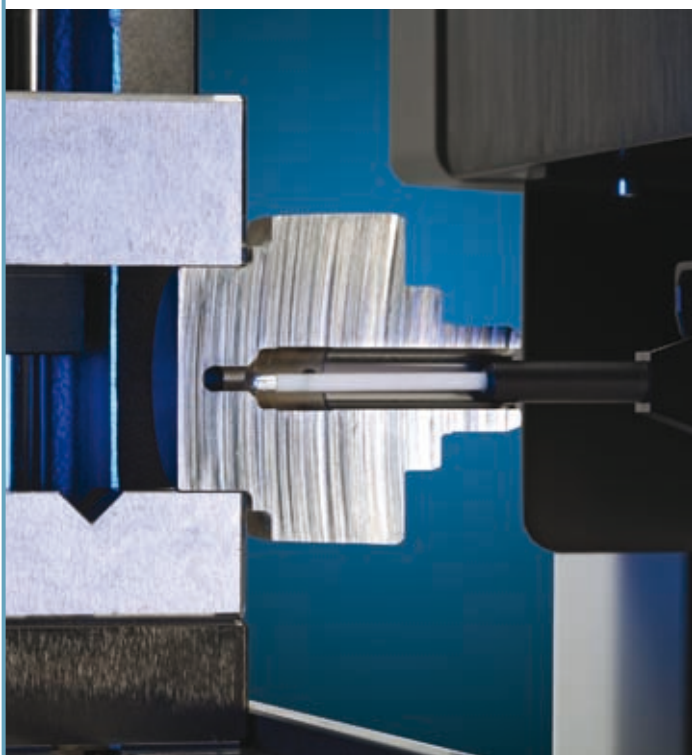

+Z measuring direction

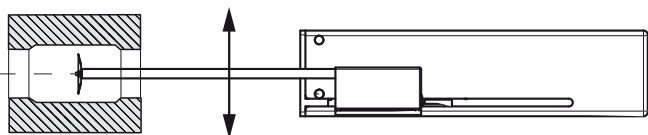

-Z measuring direction

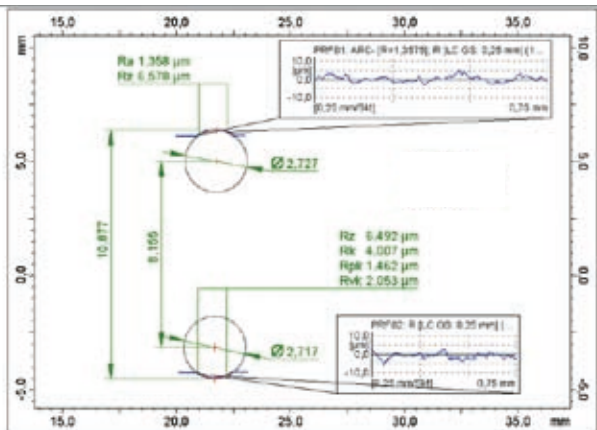
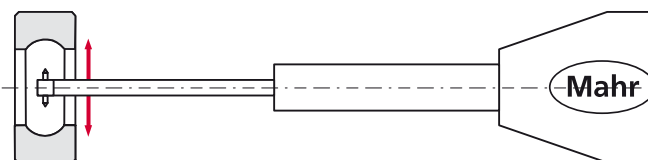

Measuring contours "above and below"

Many workpiece geometries require contour measurements on opposite faces.

With **MarSurf XC 20 / XCR 20** and the drive units **LD 120, UD 120** and **PCV 200**, this measuring task is perfectly solved. Basic requirements for this complex measurement task are:

- Reversible measuring force
- Calibrating a twin stylus
- Saving multiple profiles
- Evaluating multiple profiles

CNC Measuring Stations. MarSurf XP 20



CNC measuring station with UD 120 / LD 120 and integrated rotary table for high-precision measurement of contour and roughness.

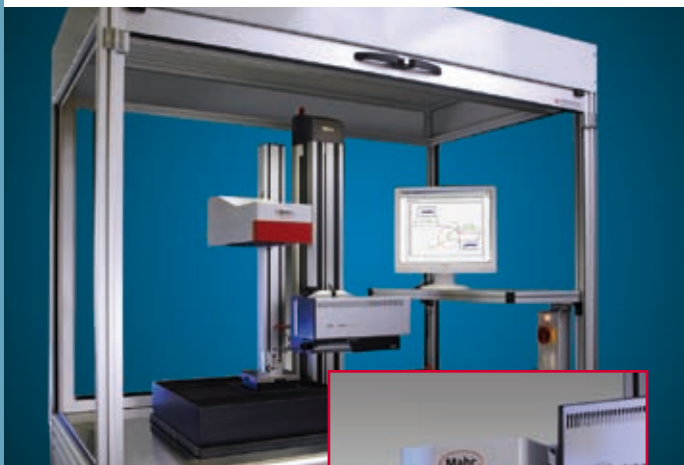

CNC measuring station with MarSurf UD 120 / LD 120 and TWE probe arm changer.

Components requiring many different measurement of many different characteristics can be measured particularly well in this measuring station configuration.

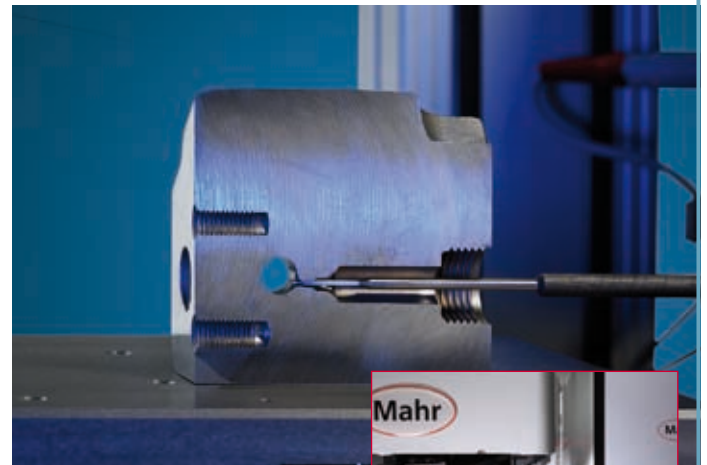

Automatically changing the probe arm enables the CNC measuring run to be performed without interruption.

You save time.

Application Examples

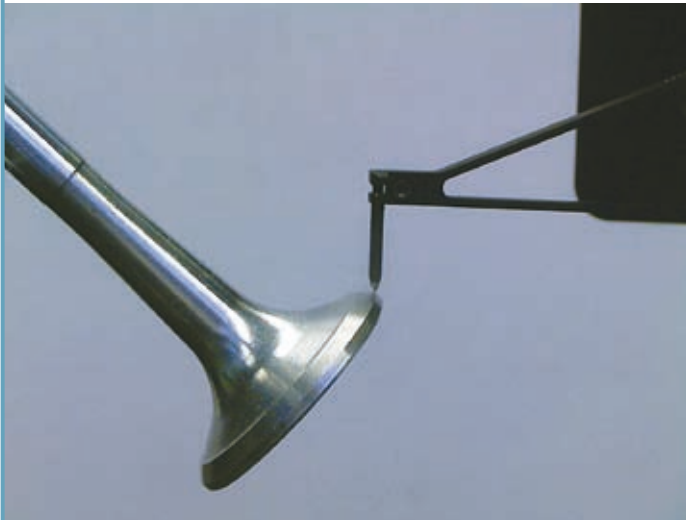

Measurement on a valve plunger

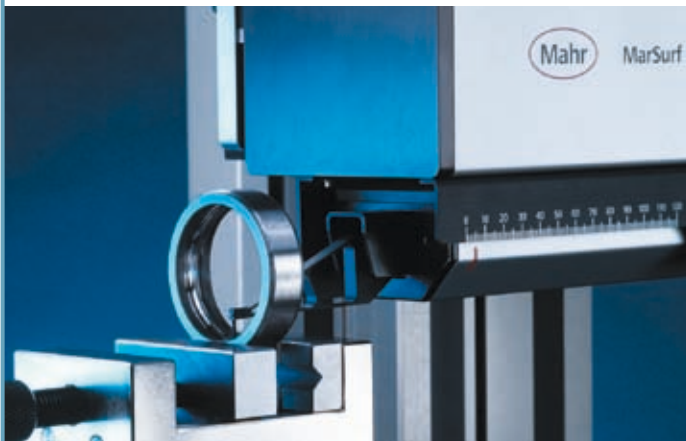
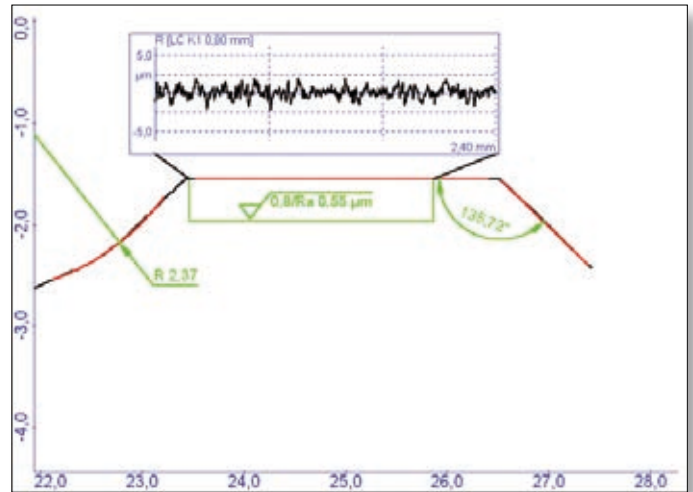

Measurement on a bearing race

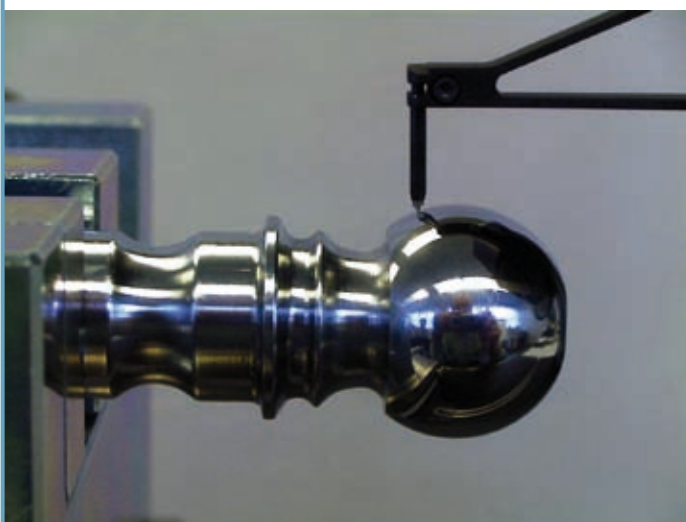
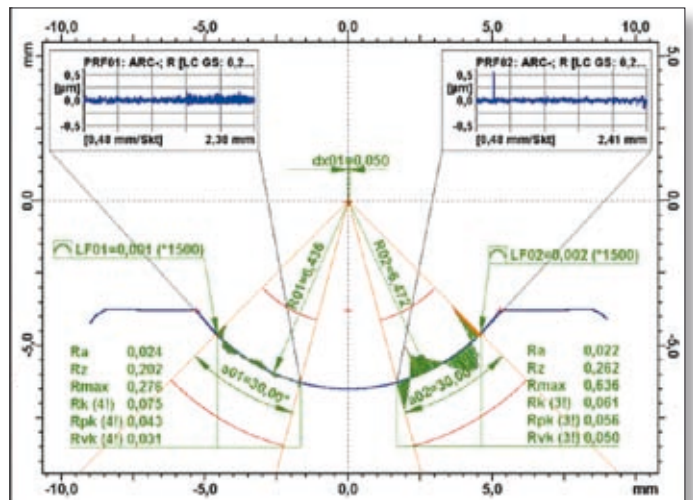

Measurement on a ball pin

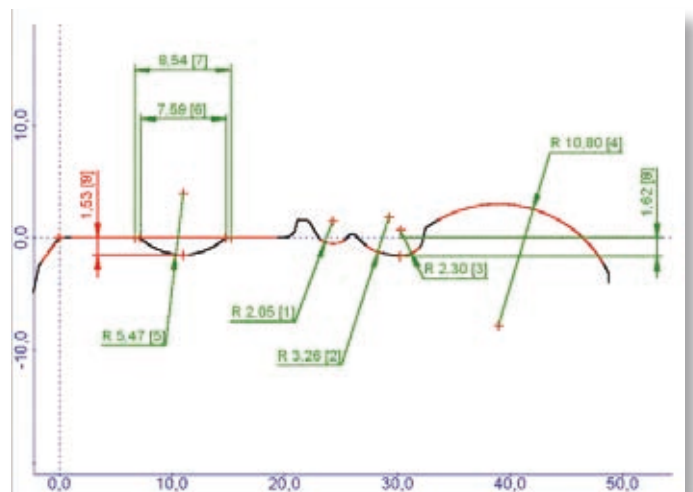

Calibration

Calibration – the basis for accurate results.

An intelligent calibration system enables measurements that are accurate on a μm scale. Geometry calibration, deflection, and measuring force calibration are key elements. An easy-to-use measuring program guides users easily and quickly through the calibration steps. As soon as a probe arm is calibrated, the data is saved, which means that, when changing probe arms, a once calibrated probe arm does not need to be recalibrated.

This standard is also suitable for calibrating the twin stylus.



Contour 1 calibration standard for MarSurf UD 120 / LD 120
Order no. 6820121

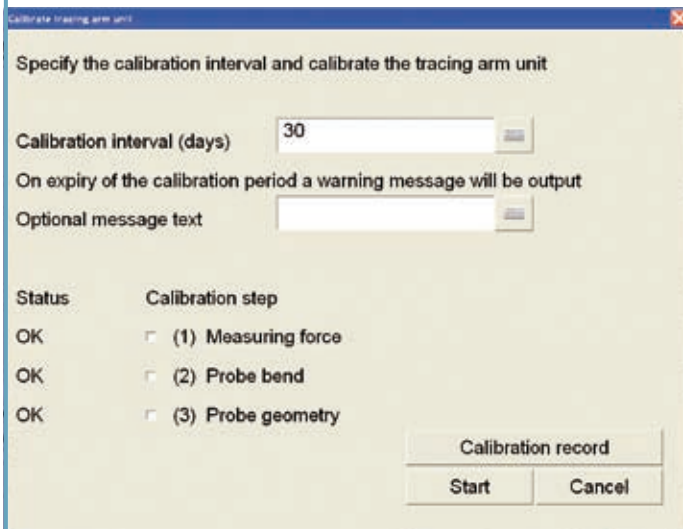

A key benefit of CD 120 / PCV 200 / LD 120 probe arms is that they can be changed without the need for tools, thanks to the use of magnetic mounts. The appropriate probe arms are therefore mounted quickly and easily for different measuring tasks.

The calibration menu enables each probe arm to be calibrated and calibration data to be saved. Calibration is only necessary once for each probe arm. No further calibration is required when changing probe arms.



KN 100 contour standard
Order no. 6820125

The KN 100 contour standard is used for a practice-oriented monitoring of the measuring station. The standard contains the key geometrical elements. The KN 100 is supplied with a DKD or Mahr certificate if required.

KN 100 DKD calibration
KN 100 Mahr calibration

Order no. 6980110
Order no. 9964316

WWW.MAHR.COM

- 0 +

Mahr

E X A C T L Y



Azma Sanat Grad

آزما صنعت گراد

تست و اندازه گیری . تجهیزات . مشاوره

Unit 3 - 2ndfloor- No.24 West Shahid Ghandi St.
North Sohrevardi Ave. Tehran . Iran
Tel : +98 21 88745209 , 86030765
Fax: +98 21 88764890

تهران - خیابان سهروردی شمالی - خیابان شهید قندی غربی
پلاک ۲۴ - ورودی غربی - طبقه دوم - واحد ۳
تلفن : ۸۶۰۳۰۷۶۵ ، ۸۸۷۴۵۲۰۹
فاکس : ۸۸۷۶۴۸۹۰

www.asgradco.com info@asgradco.com